



# snom 710

IP Phone

# User Manual

## TABLE OF CONTENTS

|  |           |
|--|-----------|
| <b>Copyright, Trademarks, GPL, Legal Disclaimers</b> .....           | <b>7</b>  |
| <b>Important information</b> .....                                   | <b>8</b>  |
| Safety instructions .....  | 8         |
| SELV (Safety Extra Low Voltage) compliance .....                     | 8         |
| Standards conformance .....  | 8         |
| Product specifications .....   | 9         |
| Disposal of the device .....   | 9         |
| Cleaning .....   | 9         |
| <b>Notational conventions</b> .....                                  | <b>10</b> |
| <b>Setting up the phone</b> .....                                    | <b>12</b> |
| Delivery Content .....   | 12        |
| Attaching and detaching the footstand .....                          | 12        |
| Rotating the tab of the cradle .....                                 | 13        |
| Connecting the phone .....   | 14        |
| Connecting a headset .....   | 15        |
| Initializing and registering the phone .....                         | 15        |
| Prerequisites .....  | 15        |
| Initialization and registration .....                                | 16        |
| What to do if initialization and registration are unsuccessful ..... | 17        |
| Correcting the clock .....   | 17        |
| <b>Getting to know your phone</b> .....                              | <b>18</b> |
| At a glance .....  | 18        |
| LED indicators .....   | 20        |
| Call indicator .....   | 20        |
| Function key LEDs .....  | 20        |
| Message LED .....  | 20        |
| Hard keys .....  | 21        |
| Freely programmable function keys with LEDs .....                    | 21        |
| Context-sensitive, programmable function keys .....                  | 21        |
| Navigation, confirmation, and cancel keys .....                      | 21        |
| Message key with LED .....   | 22        |
| Audio Control Keys .....   | 22        |
| Alphanumeric Keypad .....  | 22        |
| Input modes and navigation .....                                     | 22        |
| Entering numerals, letters, special characters, and symbols.....     | 23        |

|   |           |
|---|-----------|
| Display layout .....  | 24        |
| Idle Mode .....   | 24        |
| When the phone is active .....                                | 26        |
| Settings .....  | 27        |
| Phone menu .....  | 27        |
| The phone's web interface .....                               | 29        |
| Opening the web interface .....                               | 30        |
| How the web interface works .....                             | 31        |
| User mode/administrator mode .....                            | 32        |
| <b>Directories .....</b>                                      | <b>34</b> |
| Directory .....   | 34        |
| Definitions, explanations .....                               | 34        |
| Directory entry .....   | 34        |
| Contact Types .....   | 35        |
| Outgoing identity .....                                       | 35        |
| Group .....   | 35        |
| Ringtones .....   | 35        |
| Assigning ringtones to contact type VIP and group types ..... | 35        |
| Adding/Editing Entries on the Phone .....                     | 36        |
| Adding new entry manually .....                               | 36        |
| Adding new entry from call list .....                         | 36        |
| Adding current caller .....                                   | 36        |
| Sorting entries .....   | 36        |
| Editing existing entry .....                                  | 37        |
| Deleting an entry .....                                       | 37        |
| Adding/editing entries on the web interface .....             | 37        |
| Adding new entry .....  | 37        |
| Editing an entry .....  | 38        |
| Deleting entry on web interface .....                         | 40        |
| Dialing from phone directory .....                            | 40        |
| Deleting whole directory .....                                | 40        |
| Importing/Exporting Directory .....                           | 40        |
| External directories .....                                    | 40        |
| LDAP .....  | 40        |
| Contacts .....  | 41        |
| <b>Using the phone .....</b>                                  | <b>42</b> |
| Making calls .....  | 42        |
| Selecting identity for current outgoing call .....            | 42        |

|   |    |
|---|----|
| Using different audio devices .....                                     | 42 |
| Handset .....   | 42 |
| Headset .....   | 42 |
| Speakerphone .....  | 42 |
| Speakerphone and handset <u>or</u> headset .....                        | 42 |
| Using different dialing methods .....                                   | 43 |
| Auto dial .....   | 43 |
| Redialing .....   | 43 |
| Calling number from call history (missed, received, dialed calls) ..... | 43 |
| Calling number from phone directory .....                               | 43 |
| Speed dialing .....   | 43 |
| Calling emergency numbers .....   | 44 |
| Call completion .....   | 44 |
| Number guessing (auto completion) .....                                 | 45 |
| Accepting calls .....   | 45 |
| Using different audio devices .....                                     | 45 |
| Automatically accepting calls .....                                     | 45 |
| Call pick-up from another extension .....                               | 46 |
| Active calls .....  | 47 |
| Connected call .....  | 47 |
| Hold .....  | 47 |
| One call on hold .....  | 47 |
| Holding multiple calls .....  | 47 |
| Music on hold .....   | 48 |
| Conference .....  | 48 |
| Initiating a conference .....   | 48 |
| Conference screen navigation .....                                      | 48 |
| Putting the conference on hold .....                                    | 49 |
| Adding a participant .....  | 49 |
| Terminating the conference .....  | 49 |
| Putting one participant on hold .....                                   | 49 |
| Speaking to one participant in private .....                            | 49 |
| Dropping a participant .....  | 49 |
| Transferring calls .....  | 51 |
| Attended transfer .....   | 51 |
| Blind transfer .....  | 51 |
| Call waiting .....  | 51 |
| Terminating calls .....   | 52 |

|   |           |
|---|-----------|
| Missed Calls .....  | 52        |
| Call lists .....  | 52        |
| Rejecting or redirecting incoming calls .....                           | 53        |
| Manually .....  | 53        |
| Automatically .....   | 53        |
| Rejecting anonymous calls .....   | 54        |
| Call forwarding .....   | 54        |
| Changing the settings on the phone and turning on call forwarding.....  | 55        |
| Turning on forwarding of all calls with a programmed function key ..... | 55        |
| Turning off call forwarding .....                                       | 56        |
| <b>Configuring the function keys .....</b>                              | <b>57</b> |
| Function keys on snom phones .....                                      | 57        |
| Programming the function keys.....                                      | 58        |
| Example 1, Extension monitoring and call pick-up .....                  | 59        |
| Example 2, Monitoring calls on-screen .....                             | 60        |
| Example 3, Speed dialing .....  | 61        |
| Example 4, Turning forwarding of all calls on and off .....             | 62        |
| <b>Customizing the phone settings .....</b>                             | <b>63</b> |
| Adjusting the display.....  | 63        |
| Contrast .....  | 63        |
| Backlight .....   | 63        |
| Identities/accounts .....   | 64        |
| Configuring new identity/account .....                                  | 64        |
| Editing an existing identity/account .....                              | 66        |
| Assigning ringtones to identities .....                                 | 66        |
| Time and date formats .....   | 67        |
| Time .....  | 67        |
| Date .....  | 67        |
| Time and date settings.....   | 68        |
| Time zone .....   | 68        |
| Language settings of phone and web interface .....                      | 69        |
| Phone language .....  | 69        |
| Web interface language .....  | 69        |
| Dial tones .....  | 69        |
| Music on hold .....   | 70        |
| Streaming MoH from media server.....                                    | 71        |
| Emergency numbers .....   | 71        |
| Call forwarding .....   | 71        |
| Call completion .....   | 73        |

|  |           |
|--|-----------|
| Call waiting .....                                   | 73        |
| Hide my caller ID .....                              | 74        |
| Do not disturb mode .....                            | 74        |
| Reject anonymous calls .....                         | 74        |
| Number guessing .....                                | 75        |
| Speed dial .....                                     | 75        |
| <b>Software update .....</b>                         | <b>76</b> |
| Manual update .....                                  | 76        |
| Auto provisioning .....                              | 76        |
| <b>Troubleshooting .....</b>                         | <b>77</b> |
| Reboot .....   | 77        |
| Hard reboot .....                                    | 77        |
| Reset to factory values .....                        | 77        |
| TFTP Update .....                                    | 77        |
| Manual initialization .....                          | 77        |
| Contacting snom Support .....                        | 78        |
| Traces .....   | 79        |
| <b>Appendix 1 - Display Symbols .....</b>            | <b>80</b> |
| Symbols found in the function key line .....         | 80        |
| Display indications .....                            | 82        |
| <b>Appendix 2 - Status messages .....</b>            | <b>83</b> |
| <b>Appendix 3 - Wall Mounting .....</b>              | <b>84</b> |
| <b>Appendix 4 - Programmable Functions .....</b>     | <b>85</b> |
| Programmable functions .....                         | 85        |
| Key events .....                                     | 88        |
| <b>Appendix 5 - GNU General Public License .....</b> | <b>91</b> |

# Copyright, Trademarks, GPL, Legal Disclaimers

© 2012 snom technology Aktiengesellschaft

All Rights Reserved.

snom, the names of snom products, and snom logos are trademarks owned by snom technology AG. All other product names and names of enterprises are the property of their respective owners.

Product specifications are subject to change without notice.

snom technology AG reserves the right to revise and change this document at any time, without being obliged to announce such revisions or changes beforehand or after the fact.

Texts, images, and illustrations and their arrangement in this document are subject to the protection of copyrights and other legal rights worldwide. Their use, reproduction, and transmittal to third parties without express written permission may result in legal proceedings in the criminal courts as well as civil courts.

When this document is made available on snom's web page, snom technology AG gives its permission to download and print copies of its content for the intended purpose of using it as a manual. No parts of this document may be altered, modified or used for commercial purposes without the express written consent of snom technology AG.

Although due care has been taken in the compilation and presentation of the information in this document, the data upon which it is based may have changed in the meantime. snom therefore disclaims all warranties and liability for the accurateness, completeness, and currentness of the information published, except in the case of intention or gross negligence on the part of snom or where liability arises due to binding legal provisions.

Our firmware includes some source code that may be used and modified by anyone and everyone under the GNU Public License (GPL) (enclosed at Appendix 5), provided they, in turn, make it available to everyone else with the same licensing agreement. Please go to <http://www.snom.com/en/support/download/gpl-quellcode/> for the original GPL license and the source code of components licensed under GPL and used in snom products.

## Important information

Please read the instructions on safety and disposal and on how to set up and use the device before using it and also give them to other users to read or inform those users of their contents. Save this manual and do not give the device to third parties without it.

## Safety instructions

Follow the instructions in this manual and other applicable documentation of the device.

- If the phone is not supplied with power via an Ethernet cable, use only a power adapter expressly recommended by snom technology. Other power supplies may damage or destroy the phone, affect its behavior, or induce noise.
- Avoid placing the cables where people may trip over them or where they may be exposed to mechanical pressure as this may damage them.
- This device is for indoor use only! **NOT FOR OUTDOOR USE!**
- Do not install the device in rooms with high humidity (for example, in bathrooms, laundry rooms, damp basements). Do not immerse the device in water and do not spill or pour liquids of any kind onto or into the device.
- Do not install the device in surroundings at risk for explosions (paint shops, for example). Do not use the device if you smell gas or other potentially explosive fumes.
- Do not use the device during thunderstorms. Lightning striking the power grid may cause electric shocks.
- **Warning:** The handset contains a magnet, and its earpiece may attract small dangerous objects such as needles or pins. Please ensure before each use that no such objects are present.

## SELV (Safety Extra Low Voltage) compliance

Safety status of Input/Output connections comply with SELV requirements.

**Warning:** To avoid electric shock, do not connect safety extra-low voltage (SELV) circuits to telephone-network voltage (TNV) circuits. LAN ports contain SELV circuits, and PSTN ports contain TNV circuits. Some LAN and PSTN ports both use RJ-45 (8P8C) connectors. Use caution when connecting cables.

## Standards conformance

 This device is CE and FCC-certified and meets European and US health, safety, and environmental standards.

 Unauthorized opening, changing, or modifying the device will cause the warranty to lapse and may also result in the lapse of the CE and FCC certifications. In case of malfunction contact authorized service personnel, your seller, or snom.



## Product specifications

- **Safety:** IEC 60950-1:2007
- **Certifications:** FCC Class B, CE Mark
- **Power over Ethernet:** IEEE 802.3af, Class 1  
if PoE is not available in your network you can use a power adapter (not included in delivery) which can be purchased separately (PN 2203). :  
Output voltage: +5V DC at 1.0 A maximum  
Power output: 5W  
Input voltage: 100-240V, 50-60 Hz
- **Power consumption:** Approx. 1.76-2.32 W when using PoE
- **Input voltage:** +5V DC at 1.0 A maximum
- **Connectors:** 1 x LAN, 1 x PC: RJ45; Handset & Headset: 4P4C
- **Ethernet:** 2x10/100 Mbps switch

## Disposal of the device



This device is subject to European Directive 2002/96/EC and may not be disposed of with general household garbage.





If you do not know where you may dispose of the device at the end of its lifespan, contact your municipality, your local waste management provider, or your seller.

## Cleaning

To clean the device, use an anti-static cloth. Please avoid cleaning liquids as they might damage the surface or internal electronics of the device.

# Notational conventions

Throughout this manual you will see the below-listed symbols and notations, indicating the action you need to take next.

- Arrow symbols ▲▼◀▶: Depending on the context, they indicate either pressing the top, bottom, left, or right edge of the navigation key or pressing the function keys underneath the display symbols , , , or  when these symbols are available. Sometimes both methods will work.

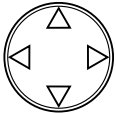
|   |   |                                     |
|---|---|-------------------------------------|
|  | ▲ | Press top edge of navigation key    |
|   | ▼ | Press bottom edge of navigation key |
|   | ◀ | Press left edge of navigation key   |
|   | ▶ | Press right edge of navigation key  |

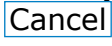
- Symbol ✓: Depending on the context, they indicate pressing either the confirmation key or the function key underneath the display symbol , when this symbol is available. Sometimes both methods will work.
- Symbol ✕: Depending on the context, they indicate pressing either the cancel key or the function key underneath the display symbol , when this symbol is available. Sometimes both methods will work.



- Menu items: Represented by number and title, e.g., "5 Maintenance".
- Sequences of **actions to be taken**. The character ">" indicates the next step in a sequence of actions to change a setting or perform a function.

Example 1:  > 1 Preferences > 4 Language > ▲▼ > ✓ > ✕

|   |   |
|---|---|
|  | Press the function key underneath this text in the function key line to open the Settings menu  |
| > 1 Preferences   | Next, press the number "1" key on the alphanumeric keypad. Alternatively press ✓.   |
| > 4 Language  | Next, press the number "4" key on the alphanumeric keypad. Alternatively, navigate to "4 Language" with the navigation key and press ✓ to open the list of available languages. |
| > ▲▼  | Scroll through the list by pressing either the up ▲ and down ▼ arrows on the navigation key.  |

|     |  |
|-----|--|
| > ✓ | Save your selection and return to the previous screen by pressing the confirmation key.  |
| > ✕ | Press the cancel key briefly to return to previous screens one screen at a time; press the key for 3 seconds to return to the idle screen. |

Example 2: Web interface > Advanced > Behavior > Phone Behavior > Number Guessing > "On"

|                   |  |
|-------------------|--|
| Web interface     | Open the phone's web interface   |
| > Advanced        | Click on the item "Advanced" in the menu on the left side of the window  |
| > Behavior        | Next, click on the tab labelled "Behavior". The <b>bold</b> lettering of the title on a tab indicates that its contents are currently visible. |
| > Phone Behavior  | Find the section titled "Phone Behavior"   |
| > Number Guessing | Find the item "Number Guessing"  |
| > "On"            | Click on the radio button "on"   |

# Setting up the phone

## Delivery Content

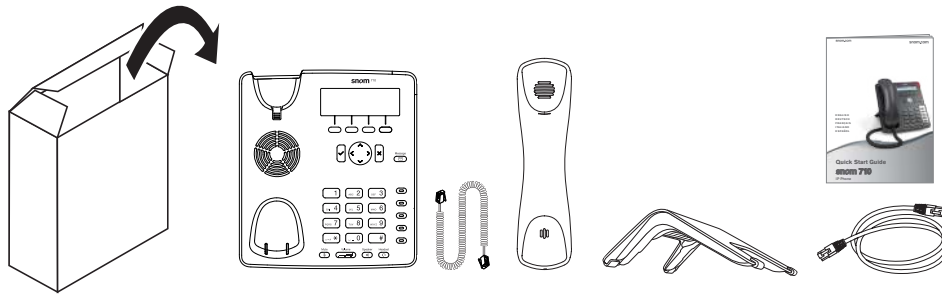

- Base phone unit
- Footstand
- Handset
- Handset cord
- Ethernet cable
- Quick Start Guide

## Attaching and detaching the footstand

The footstand can be attached at two different angles: 28° and 46°.

**Note:** Before attaching the footstand to the phone, plug the long end of the handset cord into the connector labelled "☞" on the back of the phone and place the cord in the cable guide.

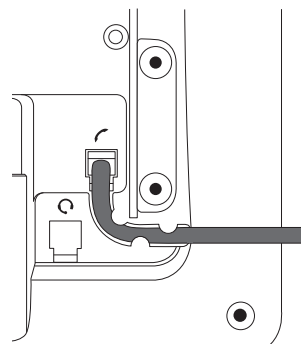

1. Place the top of the grooves on the footstand (Fig. 1) below the slideguides on the back of the phone (Fig. 2). For the upright position, the short "legs" of the footstand must be attached to the phone; for the more horizontal position, use the long ones.
2. Push the footstand upwards onto the slideguides until they lock in place (Fig. 3).

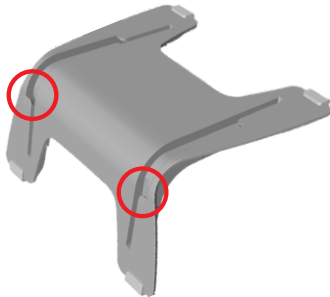

Fig./Abb. 1

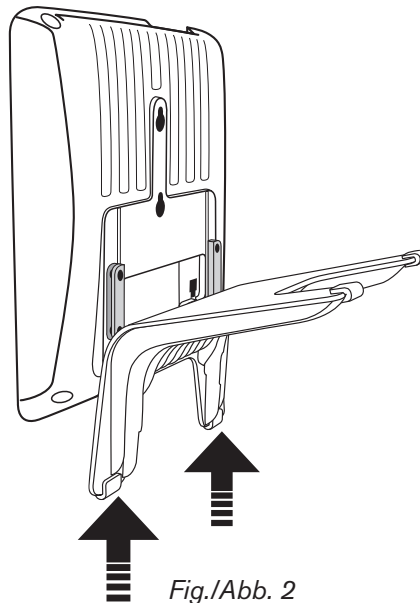

Fig./Abb. 2

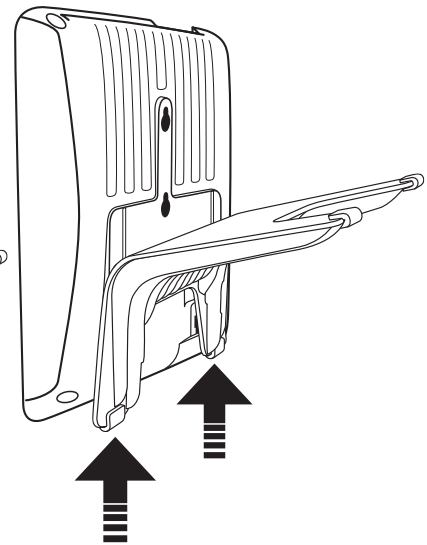

Fig./Abb. 3

3. Plug the short end of the handset cord into the connector on the handset.
4. Place the phone on an even, horizontal surface.

## Rotating the tab of the cradle

The phone is delivered with the tab level with the inner edge of the cradle. If you are going to mount the phone on a wall, we recommend that you rotate the tab 180°. After rotation, the tip of the tab will protrude slightly above the edge of the "cradle". The small rectangular hole in the receiver casing fits perfectly over the now protruding tip, holding the receiver safely in place in the upright position on the wall.

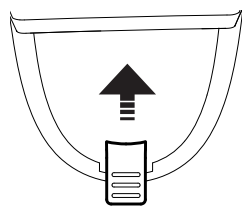

Fig./Abb. 1

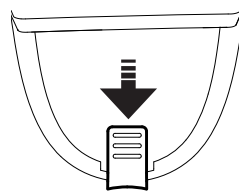

Fig./Abb. 2

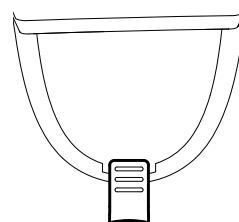

Fig./Abb. 3

1. Slide the plastic tab from the cradle (Fig. 1)
2. Rotate the tab 180°.
3. Slide the tab back into the cradle (Fig. 2). The top of the tab now protrudes slightly above the inner edge of the cradle (Fig. 3), so that it will hold the handset more securely.

The wall mounting instructions are attached at "Appendix 3 - Wall Mounting" on page 85.

## Connecting the phone

The phone can be operated with Power over Ethernet (PoE) provided via the network cable or, if PoE is not available in your network, with a 5V DC power adapter.

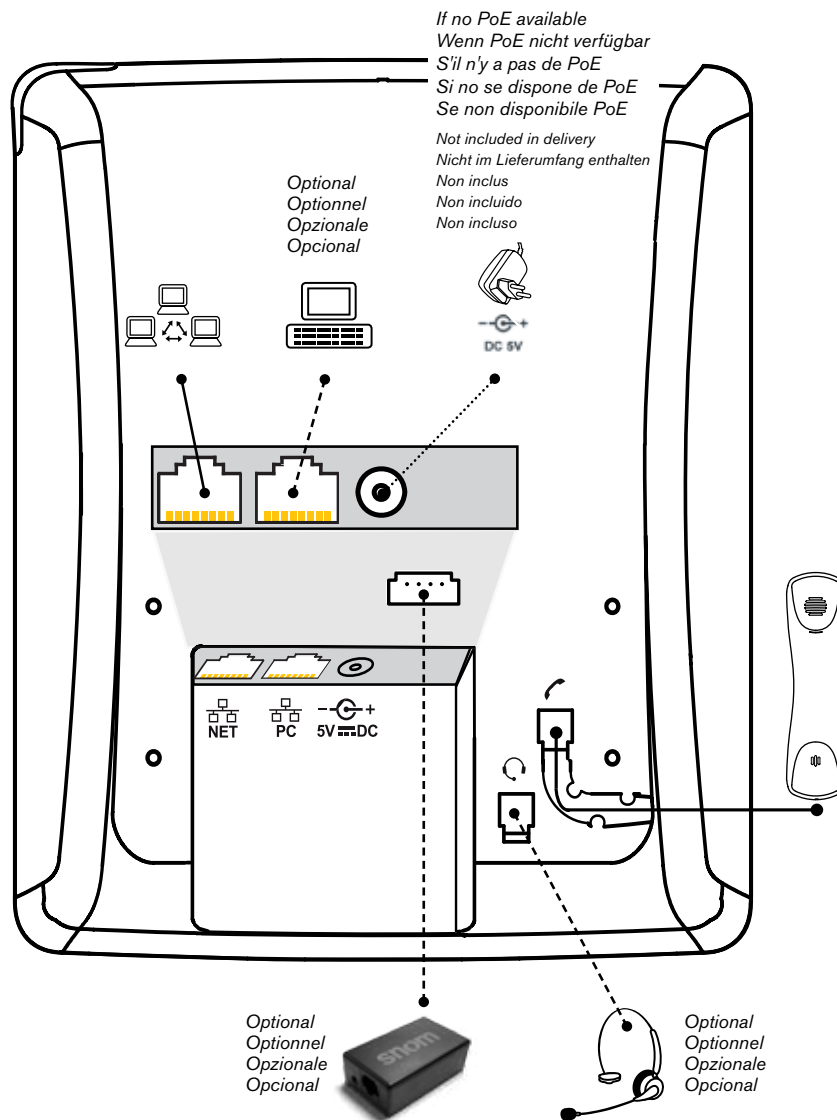

- Plug the Ethernet (network) cable into the RJ45 connector labeled “NET”, and plug the other end into the network side to establish a data link. The second RJ45 connector, labeled “PC”, is for daisy-chaining further Ethernet devices without the need for a second Ethernet connection line.
- If PoE is not available, you can use the 5V DC power supply which is available separately. Insert the plug of the power supply into the connector labeled “DC 5V” and hook up the plug to the wall outlet.

**Warning:** Other power supplies may damage or destroy the phone, affect its behavior, or induce noise.

## Connecting a headset

- If you want to use a wired headset, connect it to the RJ audio jack labeled "📞".
- If you want to use a wireless headset, you need the snom EHS Advanced wireless-headset adapter to connect to the base station of the wireless headset. Insert the plug of the 7x adapter cable into the connector on the phone, as shown in Fig. 1 and 2, below.

**Note:** You need to remove the footstand to gain access to the connector (see "Attaching and detaching the footstand" on page 12). After you have inserted the plug, make sure that the cable is lying flat against the bottomshell of the phone while you are attaching the footstand to the phone. Twisting or curling up the cable may result in damaging the cable and the wires inside it.

Please refer to the Quick Start Guide of the snom EHS Advanced and the manual of your wireless headset for further information on how to connect the snom EHS Advanced and the headset.

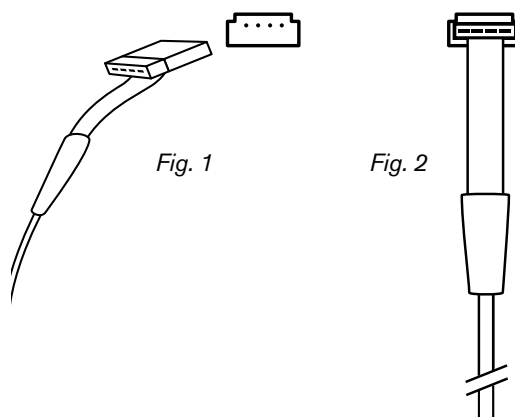

## Initializing and registering the phone

### Prerequisites

To be able to use VoIP, you or your company must have:

- A broadband internet connection.
- Access to the internet via a router. This could be a separate device available in various versions from many different manufacturers or in the form of a router on a server or a PC.
- Account information provided by your network administrator or a VoIP account with a VoIP service provider who supports the VoIP SIP standard. The phone supports up to four VoIP accounts with one or more VoIP providers.

You will need the registration information received from your Internet service provider or your network administrator. Required and optional data differ from provider to provider. They normally include:

- Account (usually the phone number). On snom phones, an account is called an "identity".
- Registrar
- Password

User name, authentication name, outbound proxy may also be required. These are settings that can only be configured on the web interface of the phone after it has been successfully registered. If your provider or your network provides a mailbox account, that setting is also configured on the web interface. For more information, see ""Identities/accounts" on page 64.

## Initialization and registration

snom phones are plug-and-play. Once the phone is connected to your network, it will begin to initialize.

**Note:** Normally the initialization is completely automatic, using DHCP. If the phone cannot discover a DHCP server in the subnet, you will be asked: Are you using DHCP? If your network does not support DHCP, press **X** and enter the IP address, netmask, IP gateway, and DNS server manually. Ask your Internet service provider or your network administrator for them.

You will then be asked on the display to make some basic settings.

1. You will be prompted in English to select a language. Use **▼▲** to select another language, if applicable, and press **✓** to save the language preceded by **▶**.
2. Next, you will be prompted in the language of your choice to select a time zone. The time zone determines the time shown on your display.
  - Press the function key underneath **Jump** to move to the beginning of the next time zone.
  - Press **▼▲** to move up or down the list one item at a time.
  - Press the function key underneath **Reduc** to show only those time zones where the selected phone language is spoken.
  - Press the function key underneath **More** to show all time zones.
  - Press **✓** to save the time zone preceded by **▶**.
3. Next, you will be prompted to select the tone scheme of a country. This affects the dial tone you hear when you pick up the receiver. Different countries use different dial tones.
  - Press **▲▼** to move up or down the list one item at a time.
  - Press **✓** to save the tone scheme of the country preceded by **▶**.
4. The display shows the "Welcome" screen. Press any key to log on.
5. Enter the account number. Save with **✓**.

**Note:** See ""Entering numerals, letters, special characters, and symbols" on page 23 on how to enter numbers and letters.

6. Enter the registrar. Press **✓**.

After successful registration you will see the phone symbol  and the registered account (identity) in the identity line underneath the date/time bar:



Infobar with date & time → 13.10.2011 15:58  
Identity line → ☎ 172

**Note:** If you see the account on the display preceded by an empty square  and the phone does not work, the server may be down, either for servicing or due to a malfunction. The registration and initialization should be completed as soon as the server is up and running again. You may want to check with your administrator or your provider if nothing happens within a reasonable amount of time.

## What to do if initialization and registration are unsuccessful

Your network or your VoIP provider may require more login data than requested by the snom phone during the initialization and registration process. This data is entered on the web interface of the phone. Contact your network system administrator or your VoIP provider for more information.

1. When you have received all necessary data, open the phone's web interface (see "Opening the web interface" on page 30).
2. Open Configuration Identity 1 and enter any additional login information you have received from your provider.

**Note:** A number of IP telephony service providers and a number of SIP PBXs require settings that are different from snom's standard factory settings. snom's web page lists numerous providers and PBXs that have been tested for interoperability with our phones and specific settings that may be required. Do not change the standard configuration unless you know what you are doing. Expert help may be required.

## Correcting the clock

The phone receives the time and date from your NTP time server. If the time and/or date on the display are incorrect, you may need to set the correct time zone.

Changing the settings: See "Time and date formats" on page 67.

If the time is still incorrect, there may be a problem with the time server. Contact your network administrator or your IP provider.

### Default formats:

- **Time.** 24-hour clock, e.g. 17:35. Changing to AM and PM formats: See "Time" on page 67.
- **Date.** US date format MM/DD/YEAR, eg. 11/23/2010. Changing to European format DD.MM.YEAR, e.g. 23.11.2010: See "Date" on page 67.

# Getting to know your phone

## At a glance

The factory settings at a glance:

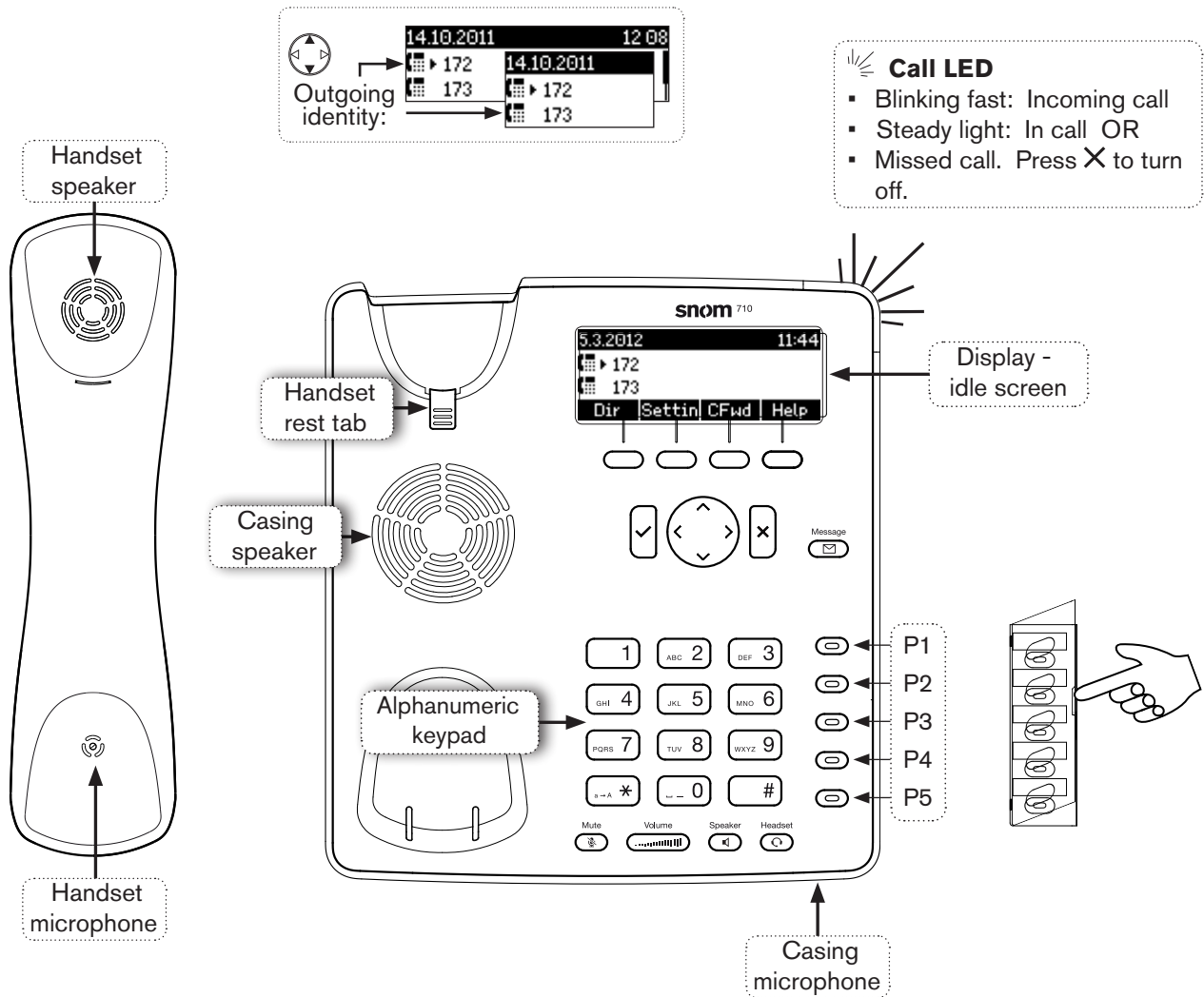

**Call LED**

- Blinking fast: Incoming call
- Steady light: In call OR
- Missed call. Press X to turn off.

**Star key**  \*

- In editing mode:
  - Press for one second to change input mode (numerals > lower case > upper case)
  - Press briefly to type \*
- On idle screen: Press for 3 seconds to **lock/unlock the keypad**

**Pound (hash) key**  #:  
Rescue mode for TFTP update

 **Message waiting key with LED**

- LED is lit when message is waiting on mailbox
- Press to listen to message(s)

**Freely programmable keys with LED** 

Default setting: Line

- Fast-blinking LED: Incoming call. Press key or ✓ to accept
- Steadily lit LED: In call
- Slow-blinking LED: Call on hold

Press the function key to activate the function, open the list etc. depicted by the symbol above the key.

### Context-sensitive, programmable function symbols and function keys

|        |  |
|--------|--|
| Dir    | Directory  |
| Settin | Settings Menu  |
| CFwd   | <span style="border: 1px solid gray; padding: 2px;">noFwd</span> Forwarding all calls (on/off)                       |
| Help   | Show IP address of phone and snom's web address. When there is status information, this function key is replaced by: |
| Info   | Status information (call forwarding active, passwords not set, missed calls, etc.)                                   |

### Navigation keys

- Confirming, saving actions & input, and returning to previous screen
- Accepting calls on speakerphone and in headset mode
- **From idle screen: Redial**

→

←

- Canceling actions & input, and returning to previous screen
- Terminating calls on speakerphone and in headset & handset modes
- Turning off call LED after missed call

- From idle screen: Selecting identity for outgoing calls

◀

▶

- In other contexts: Navigate up/down

- From idle screen ◀: Received calls
- In other contexts ◀: Navigate/space left

◀

▶

- From idle screen ▶: Missed calls
- In other contexts ▶: Navigate/space right

### Audio control keys

Adjusting the volume
 

- of the ringer when the phone is idle or ringing
- of the handset/casing loudspeaker when in a call

**Keys with LEDs** - LED lights up when function is activated:

- Muting and unmuting the microphone
- Toggling between handsfree and handset mode. Press to dial number and accept calls on speakerphone.
- Headset mode on/off

**Looking up phone's IP address during initial logon:** Press for three seconds.

## LED indicators

### Call indicator

The bright-red LEDs situated around the upper right corner of the phone indicate incoming, ongoing, held, and missed calls. They will be:

- Blinking rapidly when a call is coming in.
- Glowing steadily when dialing, when in a call, and when a call is on hold.
- Blinking slowly when there was a missed call:
  - Press **X** if you wish to turn the LEDs off without viewing the call history .
  - To view the details of the missed call press **▶** on the navigation key to show the Call History screen and simultaneously turn off the LED.

### Function key LEDs

Depending on the function mapped onto the key, the green LEDs on the key will be activated when the key event occurs. The factory setting is "line".

- When the default setting "line" is mapped onto the key, the LED will:
  - blink rapidly when a call is ringing on the line;
  - glow steadily when there is an ongoing call on the line;
  - blink slowly when a call is on hold on the line.
- When other functions are mapped onto the keys, the LEDs may also glow or blink. See also "Configuring the function keys" on page 57. Example: When the "extension" function has been mapped onto a key to monitor a specified extension, the LED will:
  - blink rapidly when a call is ringing on the extension;
  - glow steadily when the extension is busy.

### Message LED

Glowing red when there is a new message on the mailbox.

# Hard keys

## Freely programmable function keys with LEDs

These are freely programmable function keys that can be programmed on the Function Keys page of the phone's web interface, keys P1 - P5. For information on how to map functions onto these keys, see "Configuring the function keys" on page 57. The factory default setting is "line".



## Context-sensitive, programmable function keys

These are context-sensitive, programmable function keys. The functions available on the idle screen can be programmed on the "Function Keys" page of the phone's web interface. For further information, see "Configuring the function keys" on page 57.

You cannot change the functions that are available when the phone is active, for example when you are in a call, when the phone is ringing, etc. Depending on the activity, different functions will be available.

## Navigation, confirmation, and cancel keys

can be programmed with the key events available in their drop-down menus on the "Function Keys" page of the phone's web interface. See "Configuring the function keys" on page 57 for further information. The factory settings are:

|   | <b>Navigation key</b>   |
|---|---|
|  | <ul style="list-style-type: none"> <li>▲</li> <li>▼</li> </ul> <ul style="list-style-type: none"> <li>▪ On idle screen: Press to select identity for outgoing calls</li> <li>▪ In other contexts: Moving up and down lists one item/button at a time</li> </ul>               |
|   | <ul style="list-style-type: none"> <li>◀</li> </ul> <ul style="list-style-type: none"> <li>▪ In text fields, press to move the cursor to the left one character at a time.</li> <li>▪ On idle screen, press to open list of received calls.</li> </ul>                        |
|   | <ul style="list-style-type: none"> <li>▶</li> </ul> <ul style="list-style-type: none"> <li>▪ In text fields, press to move the cursor to the right one character at a time.</li> <li>▪ On idle screen, press to open the list of missed calls</li> </ul>                      |
|  | <ul style="list-style-type: none"> <li>▪ Press to accept calls on speakerphone and in headset mode.</li> <li>▪ Press to confirm actions/settings and return to preceding screen.</li> <li>▪ On idle screen: Redial.</li> </ul>  |
|  | <ul style="list-style-type: none"> <li>▪ Press to terminate calls on speakerphone and in headset and handset modes.</li> <li>▪ Press to cancel actions and return to preceding screen.</li> <li>▪ On idle screen: Press to turn off LED indicating missed call(s).</li> </ul> |

## Message key with LED

This key is a dedicated, programmable function key. It can be mapped with other key events and a number of other functionalities. See "Configuring the function keys" on page 56. Factory settings:

|  |   |
|--|---|
|  | <ul style="list-style-type: none"> <li>▪ The LED is lit when a new message is waiting on mailbox</li> <li>▪ Press the key to retrieve messages</li> </ul> |
|--|---|

## Audio Control Keys

|  |  |
|--|--|
|  | <p>Press the right or left edge of the key to adjust the volume</p> <ul style="list-style-type: none"> <li>◦ of the ringer when the phone is idle or ringing</li> <li>◦ of microphone/loudspeaker when in call</li> </ul>  |
| <b>Keys with LEDs.</b> The LED lights up when the function is activated: |  |
|  | Muting and unmuting the microphone   |
|  | <ul style="list-style-type: none"> <li>▪ Toggling between handsfree and handset mode</li> <li>▪ Dialing numbers on speakerphone</li> <li>▪ Accepting calls on speakersphone</li> </ul>   |
|  | <p>Toggling between headset and handset modes.</p> <p><b>Note:</b> Handset mode overrides headset mode. When the handset is picked up while you are using the headset, the phone switches the audio connection to the handset, and the LED of the headset key will turn off.</p> |

## Alphanumeric Keypad

### Input modes and navigation

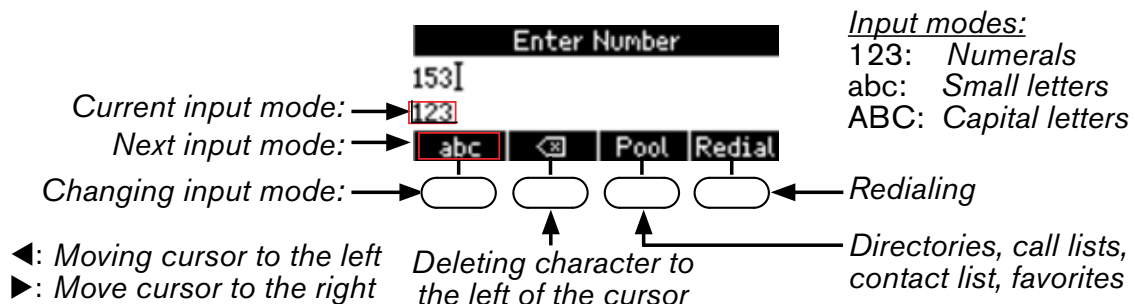

Press any key on the alphanumeric keypad or pick up handset to open the "Enter Number" screen. The current input mode is indicated in the information line underneath the cursor line. Press the left function key underneath the display to switch to the input mode indicated by the symbol directly above it in the function key line.

| Text in information line<br>= current input mode | Press function key to switch to input mode<br>indicated by symbol in Function Key Line |
|--|--|
| 123  | <input type="text" value="abc"/>   |
| abc  | <input type="text" value="ABC"/>   |
| ABC  | <input type="text" value="123"/>   |

**Entering numerals, letters, special characters, and symbols**

When entering characters in letter mode, pause briefly after each character until the cursor moves forward. Pausing is not necessary when entering numerals in numeral mode.

**Numerals.** Numeral mode is the default mode. Press the key to type the large number or symbol printed on the key. In letter mode, keep pressing the key with the desired numeral quickly until you see the numeral on the display.

**Letters.** Switch to input mode small or capital letters. To type one of the small letters printed on a key, press the key one, two, three, or four times quickly to type the first, second, third, or fourth letter printed on the key. In small letter mode, for example, press the "2" key once to type an "a", twice to type a "b", and three times to type a "c".

**Letters with accents and umlauts.** Switch to input mode small or capital letters. Keep pressing the key with the basic form of the letter quickly until you see the letter with the accent or umlaut on the display. Pause briefly after each letter. Available letters with accents and umlauts depend on the phone's language setting.

**Example** - input mode small letters: If the phone language is German, press key "2" four times to type "ä". If the phone language is French, press key "2" four times to type "à".

**Special characters and symbols.** Switch to input mode small or capital letters. Press key "0" or "1" one or more times quickly, as indicated below. Pause briefly after each character or symbol.

Press once to enter a space (" "), press twice to enter an underscore ("\_").

Press once to enter the period ("."). Press as many times as indicated to enter the special character listed in the following table:

|     |   |     |   |     |   |     |    |     |   |     |   |     |   |
|-----|---|-----|---|-----|---|-----|----|-----|---|-----|---|-----|---|
| 1x  | . | 2x  | + | 3x  | @ | 4x  | 1  | 5x  | : | 6x  | , |     |   |
| 7x  | ? | 8x  | ! | 9x  | - | 10x | _  | 11x | / | 12x | \ | 13x | ( |
| 14x | ) | 15x | ; | 16x | & | 17x | %  | 18x | * | 19x | # |     |   |
| 20x | < | 21x | = | 22x | > | 23x | \$ | 24x | [ | 25x | ] |     |   |

## Display layout

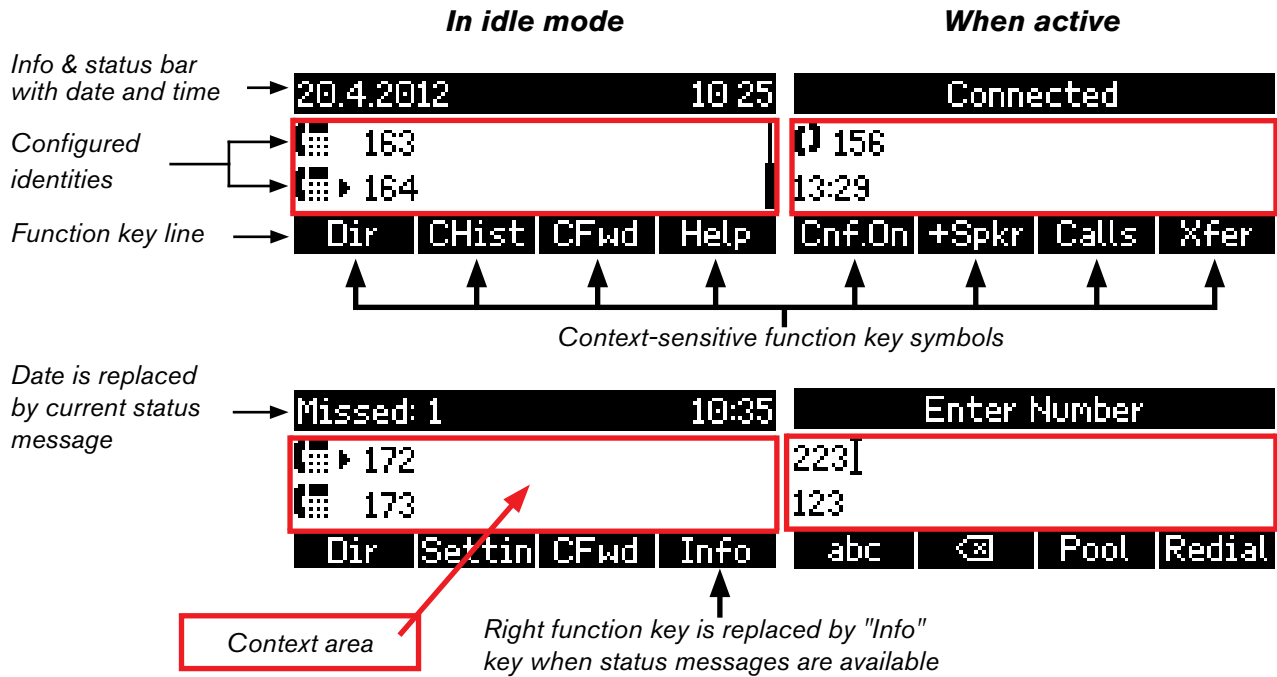

## Idle Mode

In idle mode, the display presents the following information:

**Info and status bar:** The date and time are displayed in this line, unless there is a new status message. Any of numerous messages concerning the current status of the phone will replace the date in this bar, for example missed calls, the availability of a firmware update, a reboot being required, etc. If there is more than one current status message at any one time, the one with the highest priority will be shown. For a comprehensive list in descending order of priority, see "Appendix 1 - Display Symbols" on page 79.

Two of the most common status messages you will see in idle mode are:



- The text "Missed:" and the number of missed calls since the last time you checked missed calls or turned off the missed calls indicator.
- The text "Forward" followed by "all", "on busy", or after Timeout" and the phone number incoming calls will be forwarded to. When there are missed calls, this information is replaced by the missed calls information.

Deleting status messages:

- Messages will be deleted automatically when the underlying cause is removed, i.e., call forwarding is turned off, password is set, etc.
- Manually: Press **Info**, if the button is available, or **Settin** > 6 Information > 1 Status info to open the "Status info" screen. Use **▲** / **▼** to scroll through the list. Press **Del** to delete the selected item.



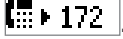





**Context area:** Configured identities.

|   |   |
|---|---|
|  | <p><b>Outgoing identity</b></p> <ul style="list-style-type: none"> <li>The current outgoing identity is indicated by the right arrow pointing towards it: . When you call someone, this is your identity for the call.</li> <li>Select a different identity for the next call by pressing ▲▼ on the navigation key.</li> </ul>   |
|  | <p><b>Active identity</b></p> <ul style="list-style-type: none"> <li>Can be called</li> <li>Can be selected as the outgoing identity for making calls by pressing ▲▼ on the navigation key.</li> </ul>  |
|  | <p>Identity not properly registered.</p>  |
|   | <p>Identities can be rendered inactive without removing the registration settings by changing their status to "inactive" on the phone's web interface. Inactive identities are not displayed on the idle screen. They cannot be called or selected as the outgoing identity. To reregister the identity, open the phone's web interface &gt; Configuration Identity (1-4).</p> <ol style="list-style-type: none"> <li>Change the "Identity active" setting to "on".</li> <li>Click on "Re-Register".</li> <li>Click on "Save".</li> </ol> |

For information on configuring new identities or modifying existing ones, see "Identities/accounts" on page 64.

**Function key line**

The symbols on the buttons in this line depict the functions that can be activated by pressing the function key underneath the respective symbol. See "Appendix 1 - Display Symbols" on page 81 for a complete list. The factory defaults are:

|   |   |  |
|---|---|--|
|  | Directory - see "Directory" on page 34  |  |
|  | Settings menu - see "Settings" on page 27   |  |
|  |    | Forwarding all calls (on/off) - see "Call forwarding" on page 54 |
|  | Phone's IP address and URL of snom's web page. This button is replaced by the  button whenever a status message becomes newly available. |  |

|      |  |
|------|--|
| Info | <p>Displaying all currently available status messages. If a different function is mapped onto this key, it will be replaced by this status key whenever a status message becomes newly available.</p> <p>Press the key to display the status messages; press <b>Del</b> to delete displayed status messages one after the other. This will also delete the message in the status bar, for example call forwarding settings. Once all messages have been deleted, both the <b>Info</b> key as well as the message in the info/status bar will disappear.</p> <p>If you have mapped a different function onto this key, it is now visible and available again. If you have mapped the function "Status messages" onto the key, the symbol's space will remain blank until there is a new status message or until a reboot when all current status messages will be displayed anew.</p> |
|------|--|

## When the phone is active

The display will inform you of any activity the phone is engaged in. This information is presented in the form of text or symbols or both.

**Info bar:** This line contains a description of the current activity, like Connected, Calls on Hold, etc.

### Context area

Depending on the activity, this area will contain symbols (incoming call ringing, outgoing call ringing, etc.) and text like the phone number calling, the extension number being called, conference partners, etc. See the various descriptions in "Using the phone" on page 42.

In editing modes (i.e., when dialing or editing directory entries), the current editing mode (i.e., numerals, small letters, or capital letters) is displayed in the line below the cursor; during active calls that line will display the duration of the call.

### Function key line

Depending on the current activity of the phone, the key function key line will present various functions that can be activated by pressing the function key underneath the respective symbol. See "Appendix 1 - Display Symbols" on page 81 for a list of available functions.

# Settings

A comparatively small number of settings can be adjusted on the phone; many more are available on the phone's web interface. For further information, see also "Customizing the phone settings" on page 62.

## Phone menu

Press the **Settin** function key to open the main menu on the display. To open a submenu and subsequent submenus, press its number on the alphanumeric keypad.

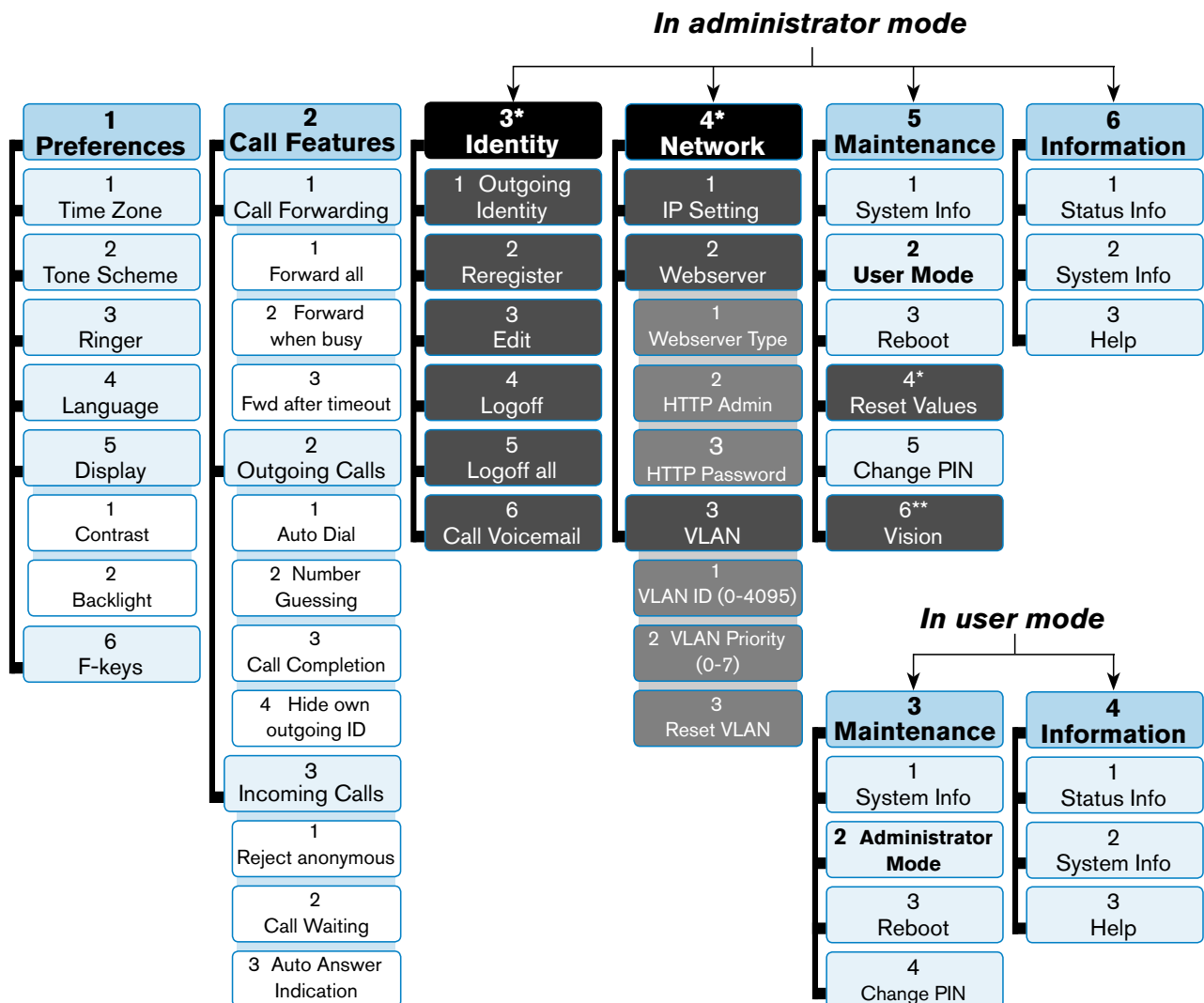

\* The submenus and the settings shaded black and gray are not available when the phone is running in user mode. The factory setting is administrator mode. For more information on user/administrator modes, see "User mode/administrator mode" on page 32.

\*\* Item 6 in the Maintenance submenu, Vision, is visible only when a snom Vision is paired with the phone or when there is a snom Vision in the network available for pairing.

**Note:** When the phone is in administrator mode and the Maintenance menu is on the display, pressing key 2  will switch the phone to user mode.

When the phone is in user mode and the Maintenance menu is on the display, press key 2  to switch the phone to administrator mode. You will be asked for the administrator password. The default administrator password is 0000 (4 x zero).

Most of the individual settings are described elsewhere in this manual: See "Using the phone" on page 42 and "Customizing the phone settings" on page 63.

# The phone's web interface

## Firmware versions below 8.7.4

When the web interface is opened for the first time upon initialization, you will see the Security page.

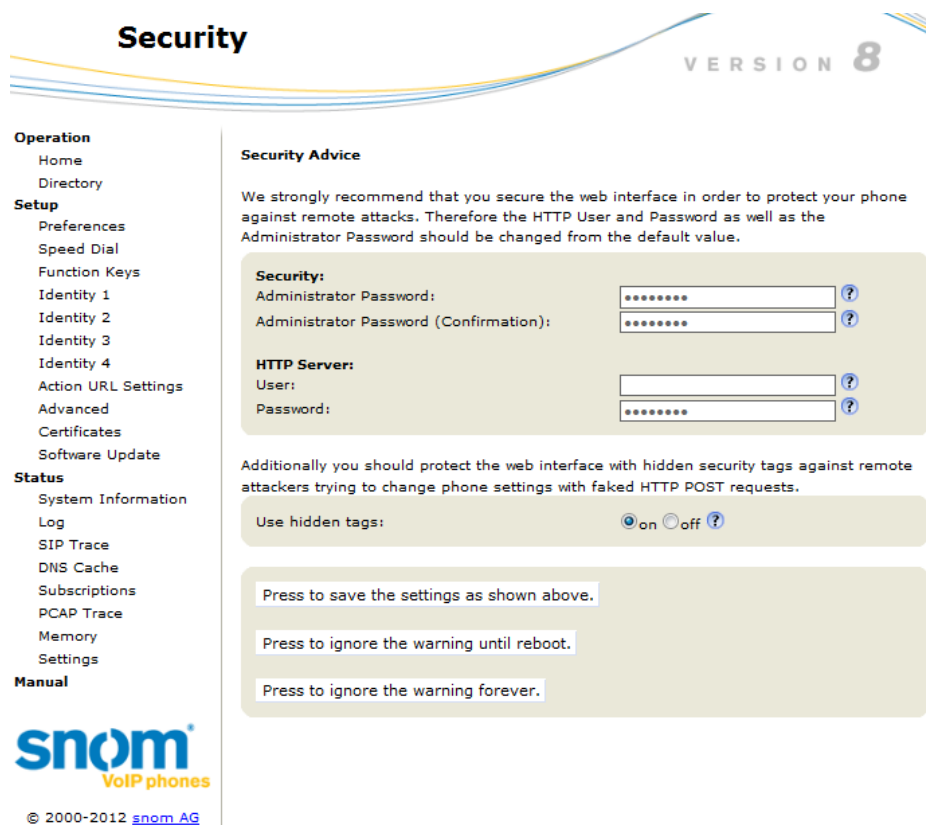

We urge you to set administrator and HTTP passwords to protect your phone from remote attacks. The default administrator password is 0000 (4 zeros); there is no default HTTP password.

### Note:

- If you do not replace the default administrator password by an individual one, an unauthorized third party with access to the phone could set an administrator password unknown to you. In such a case, you would no longer be able to switch from user mode to administrator mode. Unauthorized third parties would also be able to set the phone back to factory values.
- If you do not set an HTTP password, you make it easier for experienced hackers to break into your system.
- If you set your own passwords, be sure to write them down and store them in a secure place.

Without the administrator password, you will not be able to return the phone and the web interface from user mode to administrator mode; many settings will be inaccessible.

Without HTTP password you cannot open the phone's web interface.

If you do not wish to set an HTTP password, you can turn off the reminder on the phone's display until the next reboot or forever by clicking on the respective button. If you change your mind later, you

can set the password on the phone's web interface, "Advanced"page > "QoS Security" tab > "HTTP Server" or turn off the warning later at Advanced > QoS Security > Security > Ignore security advices.

### Firmware versions 8.7.4 and higher

When you register the first account during the initialization of the phone, your SIP user name and password will be registered as the HTTP user name and password. If you wish to change them later, you can do so on the phone's web interface > Advanced > QoS Security > HTTP Server.

**Note:**

- If you do not replace the default administrator password by an individual one, an unauthorized third party with access to the phone could set an administrator password unknown to you. In such a case, you would no longer be able to switch from user mode to administrator mode.
- If you set your own passwords, be sure to write them down and store them in a secure place.

Without the administrator password, you will not be able to return the phone and the web interface from user mode to administrator mode; many settings will be inaccessible.

Without HTTP password you cannot open the phone's web interface.

### Opening the web interface

1. Look up the phone's IP address: **Settin** > 6 Information > 2 System Info.
2. Open a web browser on your PC. Enter the IP address, preceded by "http://" in the address bar (for example: http://192.168.10.115) and press ENTER. The home screen opens.

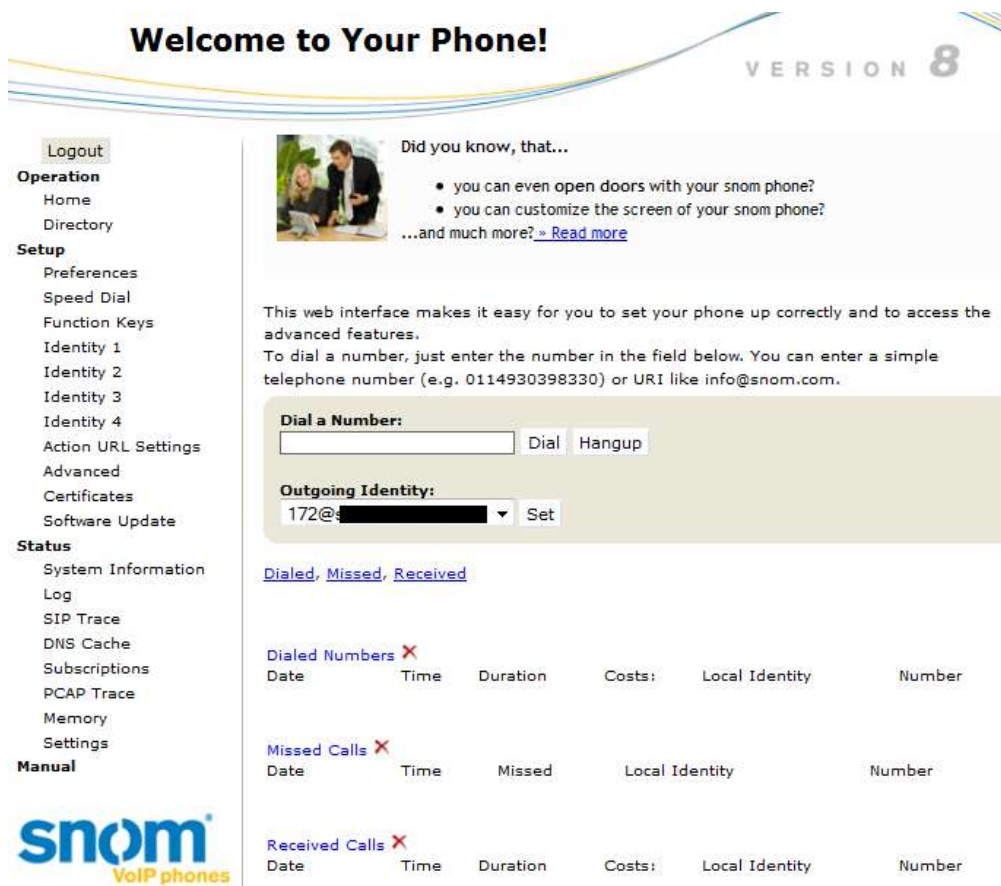

## How the web interface works

The vertical menu on the left side of the window is always the same, no matter which window happens to be open at the time. Available menu items depend on whether the phone is running in user or administrator mode.

Click on a menu item to open that page. Some pages contain several documents. To make a document visible, click on its tab. The font weight of the characters on the active tab is bold. Only one tab can be active at a time.

**Note:** Any changes you make will not take effect until you click on "Apply". Changes will be lost if you open another page of the web interface or if you close the web interface without first clicking on "Apply".

After you have clicked on "Apply", the "Save" button will appear at the top of the page. Click on "Save" to save the changes permanently. Changes that have not been saved will be lost if and when the phone loses power or is disconnected from its power source.

On the right of each setting, there is a link symbolized by the question mark. Click on this link to open a wiki page with information on the setting (description, valid and default value, links to connected issues, etc.). Click on the return button of your browser to return to the phone's web interface.

**Note:** You may have to enter your HTTP password to return to the phone's web interface.

### Web settings overriding manual phone settings

In some cases settings activated on the web interface override manual settings on the phone. If a setting you have made on the phone does not appear to take effect, look for a conflicting setting on the web interface.

## User mode/administrator mode

snom phones can be operated in administrator or user mode. In administrator mode, all settings are accessible and can be modified; in user mode, a number of settings are not accessible. The factory default is administrator mode.

When the phone is running in user mode, the administrator password is required to revert to administrator mode. The default administrator password is 0000 (4 x zero). We recommend that you change the password.

**Note:** Do not forget to write the new password down and store it in a safe place; without it, a TFTP reset to factory values is necessary to return the phone to administrator mode.

If your phone is administered centrally, user mode may be the rule. Please check with your administrator.

## User mode on the phone

In user mode, the "Identity" and "Network" menus and the setting "Reset Values" in the "Maintenance" menu are inaccessible. See also "Settings" on page 27.

## User mode on the web interface

In user mode, some windows like "Preferences" are accessible while others are not. The menu item "Advanced" is available, but the settings normally found on the page are not. In user mode, the two pages look like this:

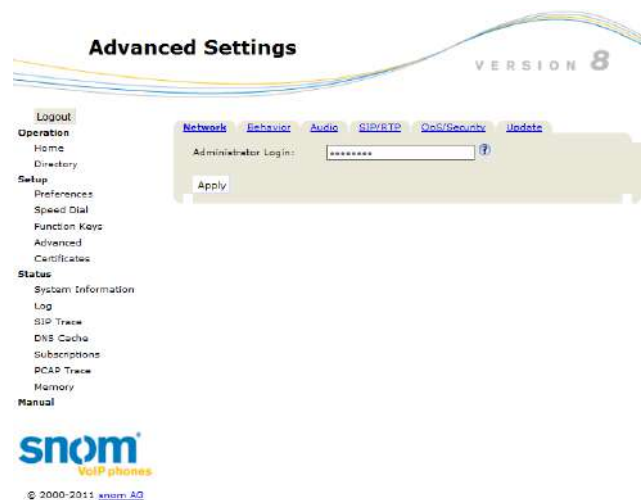
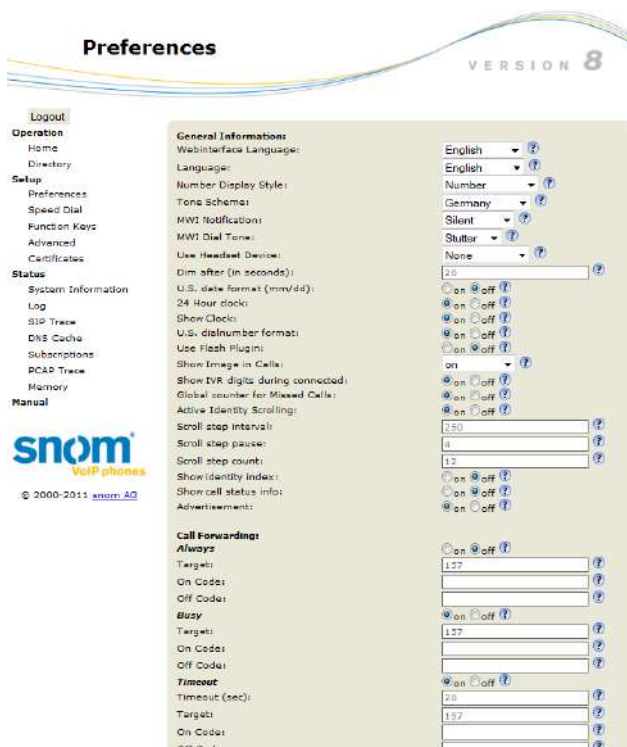



To return the phone and its web interface to administrator mode, enter the administrator password in Administrator Login and click on "Apply". The default password is 0000 (4 x zero). The two pages in administrator mode look like this:

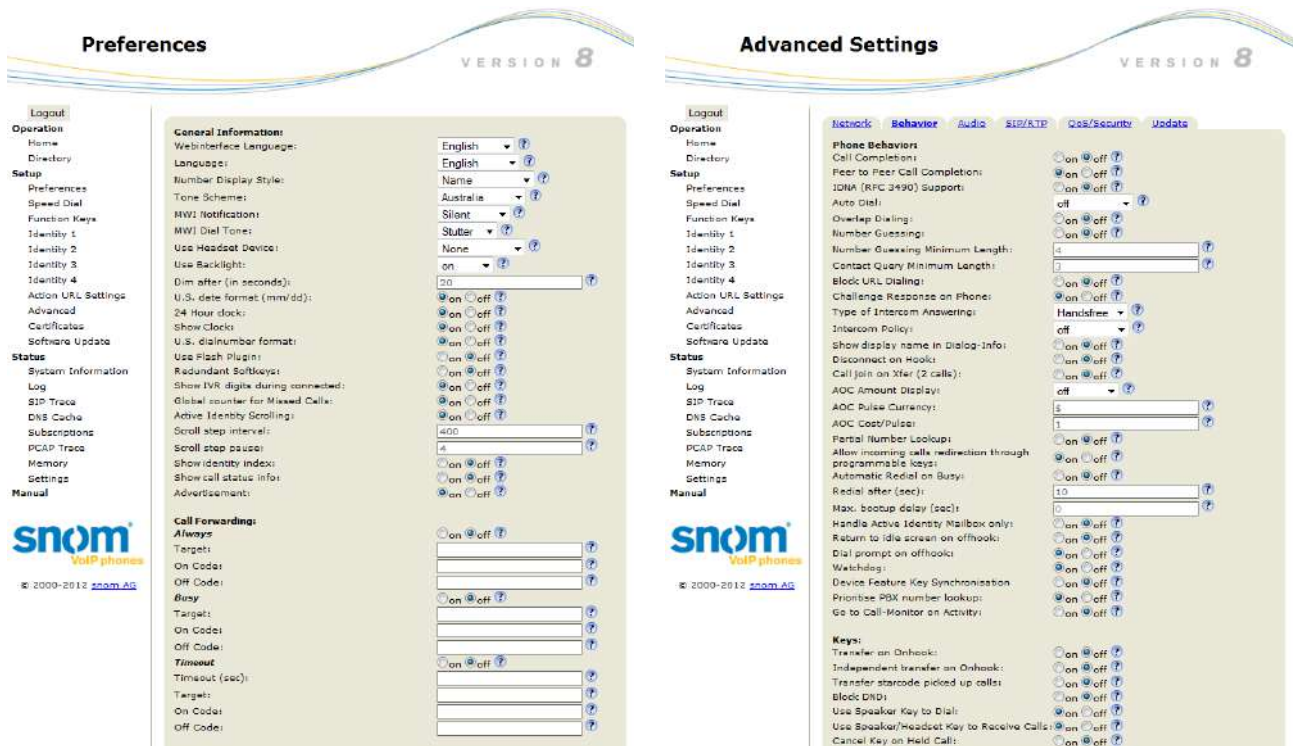

- If a window contains several pages, click on the tab at the top to open the page. The font weight of the characters on the tab of the visible page is **bold**.

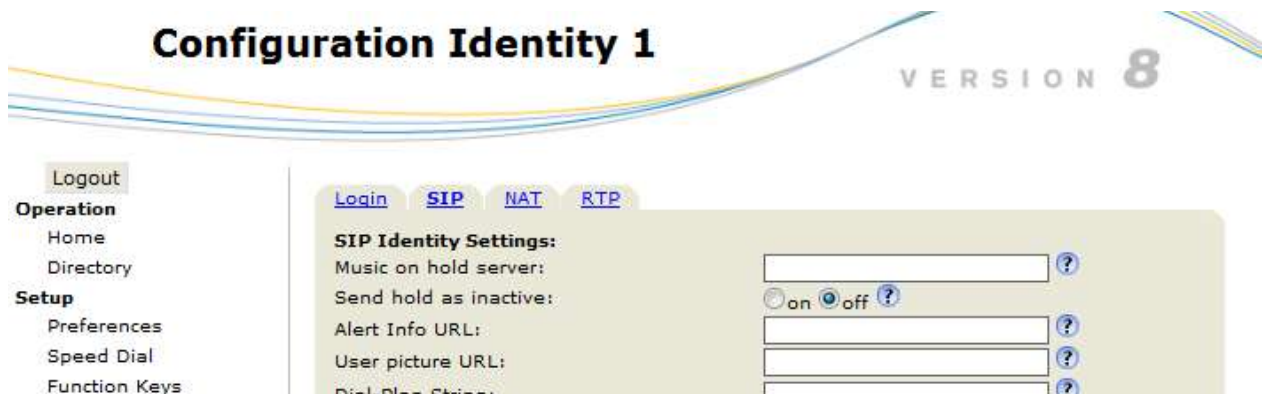

- Any changes you make will not take effect until you click on "Apply". Changes will be lost if you open another page of the web interface or if you close the web interface without first clicking on "Apply".

**Note:** Whenever you click on "Apply", the "Save" button will appear at the top of the page. Click on "Save" to save the changes permanently. Changes that have not been saved will be lost if and when the phone loses power or is disconnected from its power source.

# Directories

## Directory

The built-in directory of the phone can hold 1000 entries. Entries can be added and edited on the phone and on the web interface.

| ? Directory |            |               |                    |      |        |
|-------------|------------|---------------|--------------------|------|--------|
| Name:       | Number:    | Contact Type: | Outgoing Identity: | Edit | Delete |
| Jane Smith  | 9175554128 | None          | Active             |      |        |
| John Miller |            |               |                    |      |        |
| - fixed     | 9175554230 | None          | Active             |      |        |
| - private   | 9175557018 | None          | Active             |      |        |
| - cell      | 9175554231 | None          | Active             |      |        |

Any changes you make on the web interface will not take effect until you click on "Add/Edit". The "Save" button will then appear at the top of the page. Click on it to save the changes permanently; otherwise they will be lost if the phone loses power or is disconnected from its power source.

## Definitions, explanations

### Directory entry

Each entry must have at least one phone number; multiple associated phone numbers are possible. If you do not enter a first and/or last name and/or nickname, the phone number will appear under both "Name" and "Number".

- Entry with one phone number:

|            |            |      |        |  |  |  |
|------------|------------|------|--------|--|--|--|
| Jane Smith | 9175554128 | None | Active |  |  |  |
|------------|------------|------|--------|--|--|--|

- Entry with several associated phone numbers:

|             |            |      |        |  |  |  |
|-------------|------------|------|--------|--|--|--|
| John Miller |            |      |        |  |  |  |
| - fixed     | 9175554230 | None | Active |  |  |  |
| - private   | 9175557018 | VIP  | Active |  |  |  |
| - cell      | 9175554231 | None | Active |  |  |  |

**Number area (N):** Individual settings for the master record and each subentry possible.

**Blue area.** Data can be different for each associated phone number. If subentry textfields are blank, the data from the master record is displayed.

**Name area.** Same data for the master record and all subentries.

Master record (M)



Subentry 1



Subentry 2



Blue area of Subentry 2: Different "Group" selection (S), different entry in textfield of "Email" (S). No entry in text fields of "Title" and "Organization", therefore same as Master Record.

## Contact Types

**VIP:** Calls from numbers with this contact type will ring on your phone even when DND mode is active. You can assign a ringtone to this contact type. If your VIP is also assigned to a group (see below) and if that group has a distinct ringtone, the ringtone assigned to the group will be played.

**Deny List:** Calls from phone numbers with this contact type will not ring on your phone. The caller hears the "Busy" signal.

## Outgoing identity

The default setting is "Active" which means that the phone will use the current outgoing identity whenever you dial the number of the phone book entry.

You can also select a specific identity to be used as the outgoing identity whenever the number is dialed, for example, if you want to use a specific VoIP provider for these calls.

**Note:** To use an outgoing identity specified in the directory, you must dial the number from the directory. If you simply type it on the keypad, the current outgoing identity, as indicated on the display, will be used.

## Group

The default setting is "None". The available group types are Friends, Family, Work, Colleagues. You can assign a distinct ringtone to each group type.

## Ringtones

The phone has 10 built-in ringtones that can be assigned to identities, group types, and contact types. It is also possible to download a custom melody.

Assigning ringtones to identities: See "Assigning ringtones to identities" on page 65.

### Assigning ringtones to contact type VIP and group types

1. Open the phone's web interface > Preferences > Directory Ringtones.
2. Select a ringtone from the respective drop-down menu and click on "Apply". If you choose "Custom Melody URL", enter the URL to the data file in the text field. It must be a file of the type PCM 8 kHz 16 bit/sample (linear) mono WAV.

**Note:** Ringers assigned to contact type VIP and to any of the group types override the ringers assigned to the identities. For example, if you have assigned ringer 1 to one of the identities and ringer 2 to the group "Colleagues", the phone will play ringer 2 when a contact from the "Colleagues" group calls that identity.

## Adding/Editing Entries on the Phone

### Adding new entry manually

1. Press  to open the phone's directory.
2. Press ▲ on the navigation key to go straight to <New Item> or use navigation arrows to navigate to it.
3. Press .
4. Enter the phone number and press ✓.
5. Enter a nickname in the text field of "nick name" (optional) and/or press ✓. The "Details" screen opens.

**Note:** Entering a nickname is optional. If you don't enter one, the entry will be listed under the phone number. You can add a first and last name later by editing the entry on the phone or on the web interface.

6. See "Editing existing entry" on page 37 on how to continue.

### Adding new entry from call list

1. Open the call list:
  - Press ✓ to open the list of dialled calls.
  - Press ◀ to open the list of received calls.
  - Press ▶ to open the list of missed calls.
2. Use ▲/▼ to select a call.
3. Press .
4. Press  to add the number to the phone directory.

See "Editing existing entry" on page 37 on how to add a name, phone type, group, etc.

### Adding current caller

To be able to use this function, you must first map the "Directory" key event onto one of the freely programmable function keys with LEDs. For further information, see "Configuring the function keys" on page 56. When in a call, press the key twice during a call to add the other party's phone number to the directory.

See "Editing existing entry" on page 37 on how to add a name, phone type, group, etc.

### Sorting entries

1. Press  to open the phone's directory.
2. Press .
3. Press  /  to select the criterion for sorting (nickname, first name, last name, organization, etc.).

## Editing existing entry

1. Press  to open the phone's directory.
2. Selecting an entry: Scroll to the entry or enter the first letter of the name.
3. Press . The "Details" screen for the entry will be displayed.
4. Editing a detail.
  - a. Press ▲ / ▼ and ✓ to select a detail. Depending on the detail,
  - b. in some cases you will see the prompt screen where you can enter or modify text. Edit the data, if necessary, and press ✓ to save and to open the next screen. For information on text editing, see "Entering numerals, letters, special characters, and symbols" on page 23.

In other cases, you will see a succession of screens with context-sensitive buttons. Example: Modifying the settings of "group".

- i. Select "group" with ▼ and ✓. The "favorite" screen opens.
  - ii. Use ◀ / ▶ and ✓ to select yes or no. The "group" screen opens.
  - iii. Use ◀ / ▶ and ✓ to select family, friend, colleague, work, or none. The "contact type" screen opens.
  - iv. Use ◀ / ▶ and ✓ to select VIP, block, or none.
- c. When you are done editing the entry, press ✕.

## Deleting an entry

1. Press  to open the phone's directory.
2. Selecting an entry: Scroll to the entry or enter the first letter of the name.
 

**Note:** If there is more than one phone number associated with the entry and you want to delete only one of them, press . Select the number with ▲ ▼ and press ✓.
3. Press . You will be asked, "Are you sure?".
4. If you are, press ✓.

## Adding/editing entries on the web interface

Click on Directory in the menu on the left side of the browser window.

### Adding new entry

1. Type data in text fields of "Add or Edit Entry".
  - Number: Type the number exactly as you would dial it, with country and area codes, if necessary, and without parentheses, hyphens, blank spaces.
  - Number Type: Select the type of connection from the drop-down menu. The default setting is SIP.
  - Contact Type: Select "None", "VIP", or "Deny" from the drop-down list. The default setting is "None".

**Please note:**

Calls from entries on the "VIP" list will always ring on the phone, even when the phone is in a call or in DND mode. You can assign a distinct ringtone to the contact type "VIP": Preferences > Directory Ringtones.

Calls from entries on the "Deny" list will not ring on the phone. The caller will always hear the busy signal.

- **Outgoing Identity:** The drop-down list shows all identities configured on the phone. If you select one of the identities for the currently open phone book entry, all calls to that number **initiated from the phone book** will use that identity.
- **Blue area:** The data entered in the textfields will be displayed when the entry is opened on the phone. The data can be used to sort entries by group, name, organization, etc., and can be edited on the phone.
  - "Group" drop-down menu: Available types are "Friends", "Family", "Colleagues", or "Work". You can assign a distinct ringtone to each group type: Preferences > Directory Ringtones.
  - "Nickname": If you enter a nickname, it will appear under the "Name" header of the Directory on the web interface.
- **First name, family (last) name:** Will be added in this order under "Name" in the directory, unless you have also entered a nickname.
- **Birthday.** Uses the format set at Preferences > General information > U.S. Date Format (mm/dd): "On" or "Off". Enter in DD.MM.YR or MM/DD/YR format. Examples:

| Date             | Input                  | Output when US Date Format setting is |          |
|------------------|------------------------|---------------------------------------|----------|
|                  |                        | On                                    | Off      |
| March 5, 1980    | 5.3.80 or 3/5/1980     | 3/5/80                                | 5.3.80   |
| March 12, 1980   | 12.3.80 or 3/12/1980   | 3/12/80                               | 12.3.80  |
| October 5, 1980  | 5.10.80 or 10/5/1980   | 10/5/80                               | 5.10.80  |
| October 12, 1980 | 12.10.80 or 10/12/1980 | 10/12/80                              | 12.10.80 |

- **Favorite:** Tick box to add entry to "Favorites" list.



2. Click on "Add/Edit" to save new entry to directory.

**Editing an entry**

When you open an existing entry, the current information is displayed in the text fields of "Add or Edit Entry" and two additional buttons, "Add Sub" and "Change", are available.

- Editing.

| Name:       | Number:    | Contact Type: | Outgoing Identity: | Edit | Delete |
|-------------|------------|---------------|--------------------|------|--------|
| Jane Smith  | 9175554128 | None          | Active             |      |        |
| John Miller |            |               |                    |      |        |
| - fixed     | 9175554230 | None          | Active             |      |        |
| - private   | 9175557018 | VIP           | Active             |      |        |

- If there is only one phone number associated with a name, click on  in the entry's line.
- If there are two or more phone numbers associated with a name:
  - Click on  in the name's line if you wish to edit the first or last name, the date of birth, or any of the data in the blue area applicable to the master record.
  - Click on  in a phone number's line if you wish to edit the subentry's data (phone number, number & contact type, outgoing identity, and any blue area data applicable to this subentry only).

Make changes as necessary and click on "Change".

- Adding additional phone number(s) (subentries) to an entry
  - Jane Smith's entry has only one phone number, her SIP phone number. In this example, the phone number of Jane Smith's landline will be added to the directory.
    1. Click on  in Jane Smith's line. Current data is shown in "Add or Edit" area (Fig. 1).

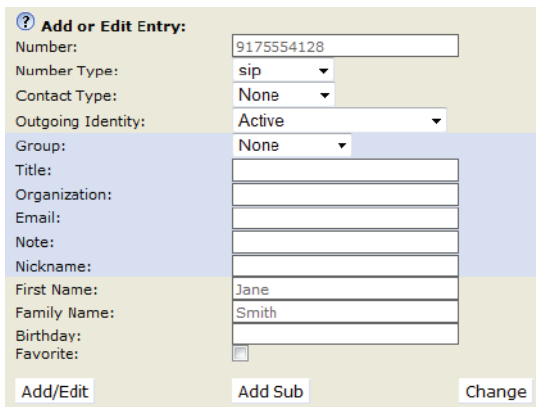

**? Add or Edit Entry:**  
 Number:   
 Number Type:   
 Contact Type:   
 Outgoing Identity:   
 Group:   
 Title:   
 Organization:   
 Email:   
 Note:   
 Nickname:   
 First Name:   
 Family Name:   
 Birthday:   
 Favorite:   
 Add/Edit      Add Sub      Change

Fig. 1

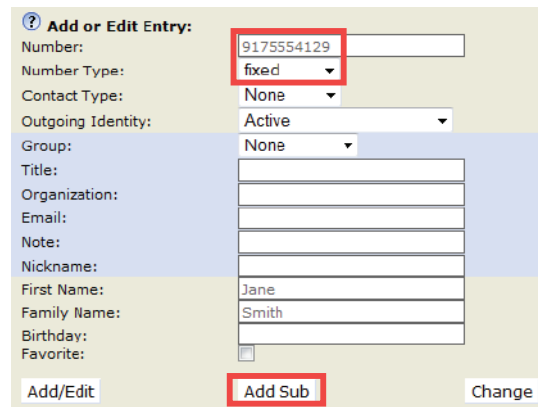

**? Add or Edit Entry:**  
 Number:   
 Number Type:   
 Contact Type:   
 Outgoing Identity:   
 Group:   
 Title:   
 Organization:   
 Email:   
 Note:   
 Nickname:   
 First Name:   
 Family Name:   
 Birthday:   
 Favorite:   
 Add/Edit      Add Sub      Change

Fig. 2

2. Enter the landline phone number in the text field of "Number" (Fig. 2).
  3. Select "fixed" from the drop-down menu of "Number type" (Fig. 2).
  4. If you wish, select a contact type and an outgoing identity from drop-down lists.
  5. Click on "Add Sub" (Fig. 2).
- John Miller's entry has a SIP number and a private number. In this example, his cell phone number will be added as a third number.
    1. Click on  in the line containing John Miller's name. The data is shown in "Add or Edit" area.
    2. Enter the cell phone number in the text field of "Number".
    3. Select the number type.
    4. If you wish, select a contact type and an outgoing identity from the respective drop-down list.
    5. Click on "Add Sub".

The directory now contains Jane Smith's landline number and John Miller's mobile phone number.

| Name:       | Number:    | Contact Type: | Outgoing Identity: | Edit | Delete |
|-------------|------------|---------------|--------------------|------|--------|
| Jane Smith  |            |               |                    |      |        |
| - sip       | 9175554128 | None          | Active             |      |        |
| - fixed     | 9175554129 | None          | Active             |      |        |
| John Miller |            |               |                    |      |        |
| - fixed     | 9175554230 | None          | Active             |      |        |
| - private   | 9175557018 | VIP           | Active             |      |        |
| - cell      | 9175554231 | None          | Active             |      |        |

### Deleting entry on web interface

- Click on in the line of the master record to delete the name and all associated phone numbers.
- Click on in the line of a phone number to delete that subentry, while keeping the master record and any other subentries.

### Dialing from phone directory

To dial, click on in the line of the phone number.

### Deleting whole directory

**Warning:** Clicking on this button deletes the entire directory irretrievably!

### Importing/Exporting Directory

**Please note:** Files to be imported must be in UTF-8 unicode format in order to display special characters properly.

To load a phone book from a file, click on the Browse button in the "Import Directory (CSV)" window of the page. Select the CSV file from the storage medium.

For more information, see our Wiki at [http://wiki.snom.com/Web\\_Interface/V7/Directory](http://wiki.snom.com/Web_Interface/V7/Directory).

## External directories

Provided by your network, your VoIP provider, or another external source.

### LDAP

To be able to access LDAP, a function key must be mapped with the function key type "Key event" and set to the value "LDAP" (see "Configuring the function keys" on page 56 for more information). Press the configured function key to open the external directory.

Enter the necessary data received from your administrator, VoIP provider or other external source in the text fields of the phone's web interface > Advanced > Network > LDAP and click on "Save".



Enter the first letter of the name you are searching for. Type more letters if the name shown isn't the right one or scroll through the list. Press ✓ to dial.

## Contacts

On the phone's web interface > Configuration Identity # > "SIP" tab > "Contact list" click on the radio button "on". Enter the URI received from your administrator, VoIP provider or other external source in the text field of "Contact list URI" and click on "Apply"/"Save".

To dial a contact on the phone, enter the first letter of the name you are searching for. Type more letters if the name shown isn't the right one, or scroll through the list. Press ✓ to dial.

# Using the phone

This section describes the functions of the phone with the factory default settings. If your phone was installed and/or set up by someone else, the default settings may have been changed. Please check with that person or company if the phone does not react as described here.

The caller information displayed on the screen is controlled by a setting on the phone's web interface. The default setting is "Number". You can change the setting at Preferences > General Information > Number Display Style by selecting a different option from the drop-down list. See "Customizing the phone settings" on page 63 for more information.

## Making calls

See "Alphanumeric Keypad" on page 22 for information on input modes and entering letters, numerals, and special characters.

### Selecting identity for current outgoing call

See "Identities/accounts" on page 64 on how to configure identities.

If more than one identity is shown on the display, the one preceded by ► is the outgoing identity for the call and the number/name that will show on the callee's phone. Use ▲ or ▼ to select another identity.

## Using different audio devices

### Handset

- Pick up the handset, enter the phone number, and press ✓. OR
- Enter the phone number and pick up the handset.

### Headset

Enter the phone number and press ✓ or headset key.

### Speakerphone

Enter the phone number and press the speaker key.

### Speakerphone and handset or headset

1. Use the method for handset or headset use to dial.
2. Press **+Spkr** to add speakerphone. Press **-Spkr** to turn speakerphone off.

## Using different dialing methods

### Auto dial

If a time span in seconds has been selected from the drop-down menu at Advanced > Behavior > Phone Behavior > Auto Dial, the phone will dial the number on the display when the specified number of seconds has elapsed.

### Redialing

1. Press ✓ to show the last 100 numbers dialed, with the very last number at the top.
2. Press ✓ to dial that number or use ▲ / ▼ to select a different number and then press ✓.

### Automatic redialing on Busy

The default for this setting is "off". Turn this feature on at Advanced > Behavior > Phone Behavior > Automatic Redial on Busy.

When a dialed number is busy, the phone will redial the number after the number of seconds entered in the text field of Advanced > Behavior > Phone Behavior > Redial after (sec.).

### Calling number from call history (missed, received, dialed calls)

1. Open the list from the idle screen:
  - Missed calls: Press the right arrow ► on the navigation key.
  - Received calls: Press the left arrow ◀ on the navigation key.
  - Dialed calls: Press the confirmation key ✓.
2. Use ▲ / ▼ to select a phone number.
3. Press ✓ to dial the number.

### Calling number from phone directory

1. Press .
2. Use ▲ / ▼ to select a name or enter the first letter(s) of the name on the alphanumeric keypad.
3. Press ✓ to dial the number.

### Speed dialing

Setting speed dial numbers: See "Speed dial" on page 74. Mapping a speed dial number onto one of the programmable virtual function keys 1-15: See "Configuring the function keys", "Example 3, Speed dialing" on page 60.

- Speed dial number on speed dial list
  1. Enter the speed dial number (0-30) or character (#, \*) assigned to the phone number you wish to dial.
  2. Press ✓ to dial.
- Speed dial number mapped onto freely programmable function key 1-16: Press the key.

### Calling emergency numbers

Numbers specified as emergency numbers can be dialled even when the keyboard is locked! See "Emergency numbers" on page 71 on how to set emergency numbers. Several numbers (911, 112, 110, 999) have been preconfigured.

- On an unlocked keyboard: Enter the number and press ✓ to dial.
- On a locked keyboard: Enter the number. The phone dials the number as soon as you have entered all the digits.

### Call completion

On snom phones call completion means that when a called number is busy or not available, your phone will notify you as soon as the dialed number is not busy anymore or available again. When a dialed number is busy or when a dialed number is ringing and not picked up, the call completion symbol or text button will appear in the function key line. Pressing the function key will activate call completion for this call.

When the dialed number is not busy anymore, your phone will ring and ask you whether it should dial the number again. Similarly, when your phone detects activity on the phone that was not picked up, your phone will wait until the activity has ceased, then ring and ask you whether it should dial the number again.

**Note:** This function depends on whether it is available in your network or not.

The factory default setting is "off". Changing the setting to turn on call completion : See "Call completion" on page 73.

When call completion is enabled and a dialed number is busy or ringing and not picked up,  will appear in the function key line. Press  to activate call completion for this call.



You can now dial another number, receive calls, or hang up the handset to return to the idle screen. Call completion will not interfere with the normal operation of your phone.

- Press  to turn off call completion for this call.
- Press  if you wish to dial another number while waiting for call completion.



When the number becomes available, you will see it announced on the display and hear a single long beep.

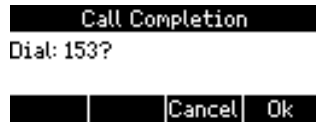

- Press  to dial.
- Press  to turn off call completion for this call.

### Number guessing (auto completion)

**Note:** The default setting for Number guessing is off. To be able to use, open the phone's web interface to **Advanced > Behavior > Phone Behavior**, change the setting to "on", and enter the minimum number of characters you must enter before number guessing will start.

When you dial and have typed the minimum number of digits, the phone will propose numbers containing the typed string from the numbers saved on its call lists and in the directory. When the desired number is on the display, press  to dial.

In the following example, the minimum number of characters is four:

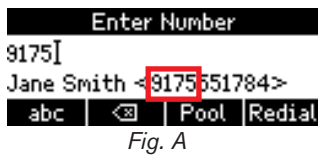

Fig. A

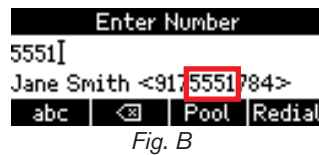

Fig. B

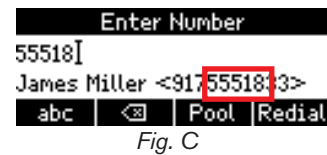

Fig. C

## Accepting calls

### Using different audio devices

**Handset:** Pick up the handset.

**Headset:** Press  or the blinking line key.

**Speakerphone:** Press .

### Automatically accepting calls

The default setting is "off". Turning the function on: On the phone's web interface **> Configuration Identity # > SIP tab > Auto answer**: Click on the radio button "On".

With this setting, your phone will automatically accept incoming calls when the phone is idle:

- If you are using Firmware version 8.7.2 and higher, calls will be accepted on speakerphone; press the headset key  if you want them to go to the headset.

- Firmware version 8.7.1 and lower: Open the phone's web interface to the page Preferences > Auto Answer > Type of Answering and select "Handsfree" (speakerphone) or "Headset" from the drop-down menu.

If you want to be alerted acoustically by a single long beep, whenever the phone accepts an incoming call, you need to change another default setting on the phones's web interface from "Off" to "On": Preferences > Auto Answer > Auto Answer Indication.

## Call pick-up from another extension

You can pick up calls ringing on another extension, for example when the other extension is busy or when the user is absent. The prerequisites for this function are:

- It must be supported by the PBX.
- The extension whose calls you wish to pick up on your own extension must permit this function and you must both be using the same ID for this function. Settings:
  - Phone's web interface > Configuration Identity > SIP > Allow incoming extension monitoring: "on"
  - Phone's web interface > Configuration Identity > SIP > Extension monitoring group ID: Enter the ID into the textfield. Please note: The first character of the ID must not be a '{' bracket.
- The extension to be monitored must be programmed onto one of the freely programmable function keys with LEDs. See "Configuring the function keys", "Example 1, Extension monitoring and call pick-up" on page 59.

When these prerequisites are met, the activities of the monitored extension are indicated by the LED of the function key:

- Blinking LED: Incoming call ringing. If the call is not answered, press the key to pick it up.
- LED glowing steadily: The monitored extension is busy (in call, dialing, etc.).

If you wish to know who is calling or connected to the monitored extensions, you can program the function "Monitor Calls" onto one of the programmable function keys (see "Configuring the function keys", "Example 2, Monitoring calls on-screen" on page 60).

- Press the key on the phone to show any ongoing activity on monitored extensions or lines on the display. For example: "153 → 157" indicates that extension 153 is calling extension 157; "153 📞 157" indicates that 153 is connected to 157 and that 153 is the caller, 157 the callee.

**Calls**  
153 → 157

Cancel ↓ ↑ Ok

*Monitored extension ringing*

**Calls**  
153 📞 157

Cancel ↓ ↑ Ok

*Monitored extension busy*

- When a call is ringing on the extension, press  to pick it up on your phone.
- Press  to close the details screen and return to the idle screen.

# Active calls

## Connected call

The connection is indicated by the symbol of the two receivers , followed by the caller or callee ID, if transmitted. The default setting for the presentation of caller ID on the display is "Name". If you wish to change the setting to number, name and number, number and name, or "full contact" (the entire URL of the connected caller/callee is displayed), open the phone's web interface > Preferences > General Information and select a setting from the drop-down menu of "Number Display Style".



## Hold

### One call on hold

- Press **Hold** or the line key of the call to put the ongoing call on hold. Held calls are indicated threefold:

- By the text on the display



- By the slowly blinking line key (green LED)
- By the glowing call indication LED (red LEDs)

You can now:

- transfer the held call blindly or with prior announcement - see "Transferring calls" on page 48.
  - receive and make calls and put other calls on hold.
- Pick up the held call by pressing its line key or by pressing **Hold** again. If the other party hangs up while on hold the call terminates on your phone as well, and the indicators are turned off.

### Holding multiple calls

When you have one call on hold and you are connected to a second call, press **Hold** or the line key to put the second call on hold. Continue likewise to put more calls on hold.





Fig. 1

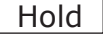







Fig. 2

When multiple calls are on hold, the status bar tells you how many there are (Fig. 1).

- Use   to scroll through the held calls. Your input on the phone's keys will affect the call

on-screen at the time, i.e., the caller shown in the contact area of the display, preceded by the symbol ....

- To connect to the held call currently on-screen, press  or the line key to connect to it. Press  or the line key again to put it back on hold.
- To terminate a held call, put it on-screen, connect to it, and press .
- To transfer a held call (blind transfer), put it on-screen, press , dial the number, and press .

If you are connected to one call and the  button is available, this indicates that there is at least one other call on hold (Fig. 2). If you wish to connect to a held call, put the current call on hold by pressing  or the line key and continue as explained above.

### Music on hold

As of firmware version 8.7.3.8, firmware downloads include a music on hold that is saved locally on the phone. The default setting for playing music to callers on hold is "off".

Changing the setting: See "Music on hold" on page 70.

### Conference

The maximum number of participants is five (your phone and four others).

#### Initiating a conference



1. Call the first intended participant and put him or her on hold.
2. Call the next intended participant and put him or her on hold.
  - Continue likewise with the third and fourth participants, if applicable.
  - You do not need to put the last participant on hold before starting the conference.
3. Press  to start the conference.

#### Conference screen navigation

Your input on the phone's keys will affect the caller/callee(s) shown in the context area of the display. For example:

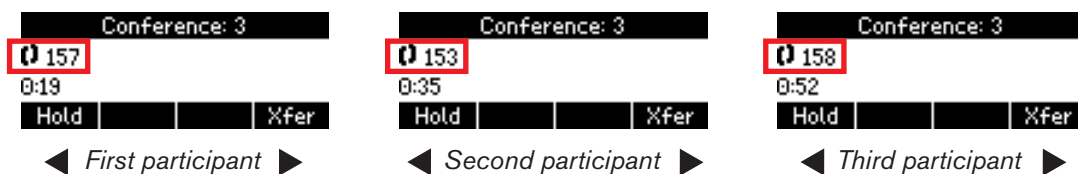
- If you have initiated a conference with three other participants, the total number of participants other than yourself is shown in the status bar.



- The upper line in the context area displays two receivers  and the number or name of the first of the other three participants. Press  to view the other participants.



## Putting the conference on hold

Put all participants on hold. Technically, you are, in effect, terminating the conference. You will see the "Calls on Hold" screen (see "Holding multiple calls" on page 47).

Press **Cnf.On** to restart the conference, i.e., start another conference with all calls on hold.

## Adding a participant

- Adding an incoming call:
  1. Press ✓ or the blinking line key to accept the call. The conference is put on hold.
  2. Press **Cnf.On** to start a conference with all held calls, including the additional participant.
- Calling a new participant:
  1. Press **Hold** to put the conference on hold.
  2. Dial the number of the new participant.
  3. With the new participant on the line, press **Cnf.On**.

## Terminating the conference

1. Press **Hold** to put all participants on hold.
2. Select each participant in turn and press ✕.

## Putting one participant on hold

1. Press the participant's line key. You need to remember which lines the individual participants are on!
2. Press **Cnf.On** to return held participant to conference.

## Speaking to one participant in private

1. Press **XFER** to put all conference participants on hold and continue as shown in "Holding multiple calls", above.

**Alternatively**, press the participant's line key **twice** to connect to that call and put the other participants on hold. This method has the disadvantage that you need to remember which lines the individual participants are on.

2. To restart the conference, press **Cnf.On**.

## Dropping a participant

1. Press the participant's line key. You need to remember which lines the individual participants are on!
2. Press ✕ to terminate the connection to this participant.

## Transferring calls

You can transfer connected calls as well as calls ringing on your phone.

- When you have a call on the line, there are two ways to transfer it to a third party:
  - Announcing the call to the third party first, to make sure the call is welcome and will be accepted: Attended transfer;
  - Transferring the call unannounced: Blind transfer. There will be no feedback on whether the third party is available and/or picking up the call.
- When a call is ringing on your phone, you can transfer it to a third party without answering it first (blind transfer only).

### Attended transfer

1. Put the call on hold.
2. Dial the number you wish to transfer the call to and announce the call.
3. If the third party wishes to accept the call, press **XFER** and ✓.

### Blind transfer

1. With a call ringing or on the line, press **XFER**.
2. Dial the number of third party you intend to transfer the call to.
3. Press ✓.

## Call waiting

When you are in a call, another incoming call will be announced visually by the **+**  symbol and acoustically by the sound of a double beep; you will also see caller ID on-screen if it is being transmitted. Switch to visual or acoustic announcement only or turn call waiting off in the drop-down menu on the phone's web interface, **Advanced > Audio > Call Waiting Indication**. See also "Call waiting" on page 72.



Single call waiting



More than one call waiting

- Press ✓ to accept the second call and put your current call on hold.
- If you do not wish to accept the call, you can:
  - ignore the announcement. If you have set call forwarding when busy, the call will be transferred to that phone.
  - transfer the call (blind transfer). Press **Xfer**, dial the number, and press ✓.
  - reject the incoming call by pressing **X**. The caller hears the busy signal. Pressing **X** for three seconds will also put the caller on the Deny list of the phone's directory. Future calls from this number will not ring on the phone; the caller hears the busy signal.

- If there is more than one call waiting, view and select them with **←** / **→**. Press **✓** to connect to the on-screen call and put the current call on hold; the other call(s) waiting will remain waiting.

## Terminating calls

- When using the handset: Place the handset in the cradle or press **X**.
- When using speakerphone or a headset: Press **X**.

## Missed Calls

Missed calls are indicated by the lit call LED and by the number of missed calls in the status line and/or on the Status info screen.

- Press **Info** to open the "Status info" screen.
- Press **X** to turn call LED off.

## Call lists

1. Press **CHist** to open Call history.
2. To view the list of missed, received, or dialed calls, press its number.
3. Scroll through the list with **▲**/**▼**.
  - Press **✓** to dial the number of the selected call.
  - Press **Del** to delete the selected call.
  - Press **Clear** to delete the entire list.
  - Press **Detail** to show call details. From the Details screen, press **Save** to add the phone number to your phone's directory. See "Editing existing entry" on page 37 for information on adding a name and other data to the new directory entry.
  - Press **X** for two seconds to return to the idle screen.

## Rejecting or redirecting incoming calls

This includes manual and automatic rejection and redirection and rejection of anonymous calls.

### Manually

If you do not wish to pick up a ringing call, you can take one of the following actions:

- Let it ring.
- Reject it. Press **X**. The caller will hear a busy signal.
- Reject the current call and place the caller on the Deny list of the phone's directory so that future calls from that number will not ring on your phone; the caller will always hear the busy signal.
  - Firmware versions 8.7.2 and higher: Press **X** for three seconds.
  - Firmware versions below 8.7.2: If the "Deny All" feature is enabled on the phone, the **Block** button is available in the function key line when an incoming call is ringing. Press the function key above it.

Enabling the feature: Open the phone's web interface > Advanced > Behavior > Phone Behavior > Deny All Feature > On.

Editing or deleting entries on the Deny list: Open the phone's web interface > Directory. See Directories, "Adding/editing entries on the web interface" on page 37 for more information.
- Do a blind transfer to another phone.
  1. Press **XFER**.
  2. Enter the number you wish to transfer the incoming call to.
  3. Press **✓** to complete the transfer. The incoming call will continue ringing at that number.

### Automatically

There are three options for rejecting incoming calls automatically or automatically or to have them forwarded automatically, either always or under certain conditions:

- Deny List. Calls from phone numbers on this list will not ring on your phone; callers will hear the busy signal. For further information on placing phone numbers on the Deny List, see Directory.
- DND - do not disturb mode. All incoming calls will be forwarded to the number set in call forwarding when busy; if there is no setting for call forwarding, callers will hear the busy signal.

**Exception:** Phone numbers designated VIP in your phone's directory will ring on your phone even when DND is on.

For information on mapping functions onto function keys, see "Programming the function keys" on page 57.

- Call forwarding. For further information, see "Call forwarding" on page 53.

## Rejecting anonymous calls

With this setting you can make your phone reject calls from phones that are blocking or not transmitting their numbers.

**Please note:** Calls from analog phone connections without caller ID will, most likely, be received as anonymous calls. They will be rejected if you turn this function on.

Activating rejection of anonymous calls:

1. Press **Settin**.
2. Press 2 Call Features.
3. Press 3 Incoming Calls.
4. Press 1 to change setting "1  Reject anonymous" to "1  Reject anonymous".
5. Press **X** for two seconds to return to the idle screen.

Deactivating rejection of anonymous calls:

1. Press **Settin**.
2. Press 2 Call Features.
3. Press 3 Incoming Calls.
4. Press 1 to change setting "1  Reject anonymous" to "1  Reject anonymous".
5. Press **X** for two seconds to return to the idle screen.

## Call forwarding

The phone can be set to forward incoming calls, either always or under certain conditions. The settings can be done on the phone and on the web interface. For further information on using the web interface for these settings, see "Call forwarding" on page 70.

**Forward All:** Forwarding all incoming calls to the number of the phone, extension, or mailbox specified as this function's target.

As the default setting, the function key **CFwd** in the function key line turns forwarding of all calls on and off, but you can also map the function onto another function key or use the settings menu as shown in the table, below.

**Forward when Busy:** Forwarding calls ringing while phone is busy to the number of the phone, extension, or mailbox specified as this function's target.

**Forward after Timeout:** When a call starts ringing, the phone will wait for the number of seconds specified in the setting "Call forwarding time". If the call is not accepted by the end of this time period, it is forwarded to the number of the phone, extension, or mailbox specified as this function's target.

## Changing the settings on the phone and turning on call forwarding

|       | Forward all                                  | Forward when busy                            | Forward after timeout                        |
|-------|--|--|--|
| Press | <b>Settin</b>                                | <b>Settin</b>                                | <b>Settin</b>                                |
| Press | <b>ABC 2</b> 2 Call Features                 | <b>ABC 2</b> 2 Call Features                 | <b>ABC 2</b> 2 Call Features                 |
| Press | <b>1</b> 1 Call Forwarding                   | <b>1</b> 1 Call Forwarding                   | <b>1</b> 1 Call Forwarding                   |
| Press | <b>1</b> 1 Forward All                       | <b>ABC 2</b> 2 When Busy                     | <b>DEF 3</b> 3 On Timeout                    |
| Press | <b>ABC 2</b> 2 Target                        | <b>ABC 2</b> 2 Target                        | <b>ABC 2</b> 2 Target                        |
| Type  | phone number                                 | phone number                                 | phone number                                 |
| Press | ✓  | ✓  | ✓  |
| Press | -  | -  | <b>DEF 3</b> 3 Time                          |
| Type  | -  | -  | number of seconds                            |
| Press | -  | -  | ✓  |
| Press | <b>1</b> 1 <input type="checkbox"/> Activate | <b>1</b> 1 <input type="checkbox"/> Activate | <b>1</b> 1 <input type="checkbox"/> Activate |

The setting will change to "1  Activate", indicating that call forwarding is now active. Press **X** for two seconds to return to the idle screen.

The status line and the status info screen will indicate that call forwarding is turned on and what number calls will be forwarded to.

**Note:** Forwarding when busy and after timeout are indicated in the status bar, which can display only one message at a time. When both are active at the same time, only "Forward when busy" will be displayed. If there are other status messages with a higher priority than "Forward when Busy" (e.g., firmware update available, reboot required, waiting for call completion, etc.), they will take precedence over the call forwarding indication.

Press **Info** to show status information with all current status messages, including call forwarding.

Forwarding all calls:

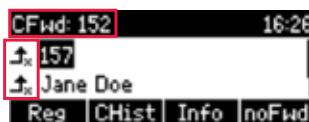

Forwarding when busy or after timeout:

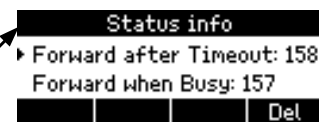
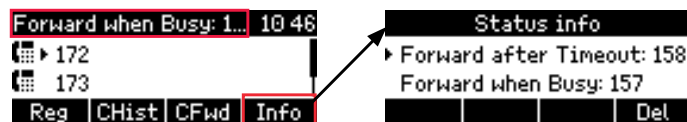

### Turning on forwarding of all calls with a programmed function key

If the function key **CFwd** is not available when the display is in idle mode, you can make it available on the Function Keys page of the phone's web interface. For further information see "Example 4, Turning forwarding of all calls on and off" on page 61.

1. Press **CFwd**. The display will show the "Target when Forwarding" screen.
2. If no forwarding number has been set or if it needs to be changed, make the necessary entries.

3. Press ✓.

The display now says "Forward all", followed by the number/extension calls will be forwarded to. The function key now reads noFwd.

**Turning off forwarding of all calls with the programmed function key**

Press noFwd.

**Turning off call forwarding**

|       | Forward all  | Forward when busy  | Forward after timeout  |
|-------|--|--|--|
| Press | <span style="border: 1px solid black; padding: 2px;">Settin</span>   | <span style="border: 1px solid black; padding: 2px;">Settin</span>   | <span style="border: 1px solid black; padding: 2px;">Settin</span>   |
| Press | <span style="border: 1px solid black; padding: 2px;">ABC 2</span> 2 Call Features                            | <span style="border: 1px solid black; padding: 2px;">ABC 2</span> 2 Call Features                            | <span style="border: 1px solid black; padding: 2px;">ABC 2</span> 2 Call Features                            |
| Press | <span style="border: 1px solid black; padding: 2px;">1</span> 1 Call Forwarding                              | <span style="border: 1px solid black; padding: 2px;">1</span> 1 Call Forwarding                              | <span style="border: 1px solid black; padding: 2px;">1</span> 1 Call Forwarding                              |
| Press | <span style="border: 1px solid black; padding: 2px;">1</span> 1 Forward All                                  | <span style="border: 1px solid black; padding: 2px;">ABC 2</span> 2 When Busy                                | <span style="border: 1px solid black; padding: 2px;">DEF 3</span> 3 On Timeout                               |
| Press | <span style="border: 1px solid black; padding: 2px;">1</span> 1 <input checked="" type="checkbox"/> Activate | <span style="border: 1px solid black; padding: 2px;">1</span> 1 <input checked="" type="checkbox"/> Activate | <span style="border: 1px solid black; padding: 2px;">1</span> 1 <input checked="" type="checkbox"/> Activate |

The menu item changes to "1  Activate", indicating that call forwarding is now off. Press ✕ for two seconds to return to the idle screen.

**Turning off forwarding of all calls with the programmed function key**

Press noFwd.

# Configuring the function keys

See "The phone's web interface" on page 29 on how to open the phone's web interface and on the mechanics of navigating in the windows and changing the settings. See "User mode/administrator mode" on page 32 for an explanation of administrator and user mode.

Any changes you make will not take effect until you press "Apply" and "Save". Changes will be lost if you open another page of the web interface without first pressing "Apply"/"Save".

## Function keys on snom phones

Every phone has a limited number of hard keys. Phone users, however, have a myriad of different priorities and preferences when asked which functions they use most often and which functionalities they would like to access quickly. snom has therefore designed the function keys to be programmable, even the preprogrammed "hard keys" whose default function is printed on the casing.

The phone has four types of programmable function keys: See "At a glance" on page 18 for an illustration.

- Freely programmable function keys with LEDs (P1 - P5). All available functionalities, including key events, can be programmed onto them.
  - **Context**

This setting specifies which configured identity will be used when executing the functionality of the key. You may want to use this feature when you have accounts with different providers or when you wish to present different identities to certain destinations.

For example: If you have programmed key P5 to speed dial a specific number and you want to use configured identity 2 to call that number, select configured identity 2 from the drop-down menu of P5's "Context". When you speed dial the number by pressing key P5, identity 2 will be used as the outgoing identity.

The default setting is "Active", which means that the identity selected as the phone's outgoing identity at any given time will be used.
  - **Type**

Select the type of functionality from the drop-down list. If you select "Key Event", a drop-down list with the available key events will replace the text field under "Number". The default setting is "line".
  - **Number**

Enter one phone number or value for the function or, if the function is key event, select an event from the drop-down list. Enter phone numbers exactly the way they need to be dialed, i.e, type the number without spaces or punctuation marks between the digits. For example, a number with an area code that might conventionally be notated as (916) 555-1234 should be entered as 9165551234.
  - **Short Text**

This entry is optional. It can be used to enter the name associated with the phone number or other descriptive text.



- Context-sensitive, programmable function keys. When there is activity on the phone, the currently available functions will be represented by symbols in the function key line. For example: When you are dialing, the available function keys are input mode selection, backspace, directory access, and redial. Other key events can be programmed onto them.
- Navigation, confirmation, and cancel keys. Other key events can be programmed onto them.
- Dedicated, customizable function keys. Other key events and a selected number of other functionalities can be programmed onto them.

## Programming the function keys

This chapter will show you a few examples for customizing function key settings to your needs and preferences:

- First example: Extension monitoring and call pickup via a freely programmable function key with LED
- Second example: Monitoring calls on-screen
- Third example: Speed dialing with a freely programmable function key with LED
- Fourth example: Turning forwarding of all calls on and off with a context-sensitive, programmable function key

### Example 1, Extension monitoring and call pick-up

This feature makes it possible to pick up a call ringing on another extension, for example when the other extension is busy or when the user is absent. The prerequisites for this function are:

- It must be supported by the PBX.
- The extension whose calls you wish to pick up on your own extension must permit this function and you must both be using the same ID for this function. Settings:
  - Phone's web interface > Configuration Identity > SIP > Allow incoming extension monitoring: "on"
  - Phone's web interface > Configuration Identity > SIP > Extension monitoring group ID: Enter the ID into the textfield. Please note: The first character of the ID must not be a '{' brace.
- The extension to be monitored must be programmed onto one of the freely programmable function keys with LEDs. In our example we are monitoring the number of the Sales Hotline on key P5.

| Context | Type      | Number                     | Short Text    |    |
|---------|-----------|----------------------------|---------------|----|
| Active  | Line      |                            |               | P1 |
| Active  | Line      |                            |               | P2 |
| Active  | Line      |                            |               | P3 |
| Active  | Key Event | Monitor Calls              |               | P4 |
| Active  | Extension | <:sip:157@ser.intern.snom. | Sales Hotline | P5 |

1. On the phone's web interface, click on "Function Keys" in the menu on the left.
2. Under "Context" of P5, select Active or one of the configured identities from the drop-down list.
3. Under "Type" of P5, select "Extension" from the drop-down list.
4. Under "Number" of P5, enter the phone number whose calls you wish to pick up. In our example it is 157.
5. Under "Short Text" of P5, enter "Sales Hotline" in the text field (optional, but helpful).
6. Click on "Apply" and "Save".

The LED of key P5 on the phone will now flash quickly when a call is ringing on 157. If the call is not answered, you can pick it up by pressing key P5. When 157 is engaged in a call, the key will glow steadily.

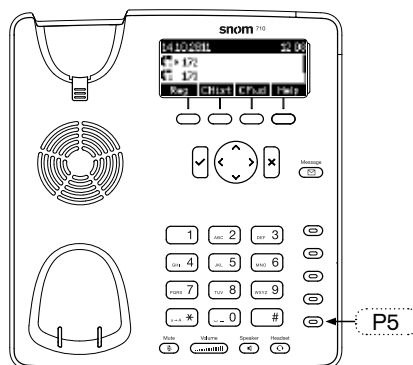

### Example 2, Monitoring calls on-screen

When you are monitoring another extension or phone line, you may want to see more information on the display, for example the number of an incoming call to that extension or line. In our example, key P4 will be programmed to show ongoing activity on monitored extensions or lines on the display.

| Context | Type      | Number                     | Short Text    |    |
|---------|-----------|----------------------------|---------------|----|
| Active  | Line      |                            |               | P1 |
| Active  | Line      |                            |               | P2 |
| Active  | Line      |                            |               | P3 |
| Active  | Key Event | Monitor Calls              |               | P4 |
| Active  | Extension | < sip:157@ser.intern.snom. | Sales Hotline | P5 |

1. On the phone's web interface, click on "Function Keys" in the menu on the left.
2. Under "Context" of P4, select Active or one of the configured identities from the drop-down list.
3. Under "Type" of P4, select "Key Event" from the drop-down list.
4. Under "Number" of P4, select "Monitor Calls" from the drop-down list.
5. Click on "Apply" and "Save".

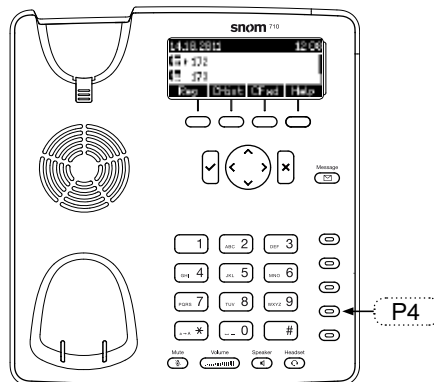

Press key P4 on the phone to show any ongoing activity on monitored extensions or lines on the display. For example: "153 → 157" indicates that extension 153 is calling extension 157; "153 ☎ 157" (or "153 ☎ 157") indicates that 153 is connected to 157 and that 153 is the caller, 157 the callee.

**Calls**

153 → 157

Cancel ↓ ↑ Ok

Monitored extension ringing

**Calls**

153 ☎ 157

Cancel ↓ ↑ Ok

Monitored extension busy

### Example 3, Speed dialing

Besides using the "Speed Dial" page on the web interface to program speed dial numbers, you can also put the functionality on the freely programmable function keys with LEDs. In our example, key P3 will be used.

| Context    | Type       | Number               | Short Text             |    |
|------------|------------|----------------------|------------------------|----|
| Active     | Line       |                      |                        | P1 |
| Active     | Line       |                      |                        | P2 |
| Active     | Speed Dial | 9175551784           | Important Partner Inc. | P3 |
| Active     | Key Event  | Monitor Calls        |                        | P4 |
| Identity 3 | Extension  | <sip:157@s[REDACTED] | Sales Hotline          | P5 |

1. On the phone's web interface, click on "Function Keys" in the menu on the left.
2. Under "Context" of P3, select Active or one of the configured identities from the drop-down list.
3. Under "Type" of P3, select "Speed Dial" from the drop-down list.
4. Under "Number" of P3, enter the phone number that you wish to speed dial. In our example it is phone number 555-1784 in area code 917. Type each phone number with any necessary area code and/or country code etc. without spaces, hyphens, etc.

Example: In conventional notation you might write the number as (917) 555-1784. Type 9175551784 into the text field.

5. Under "Short Text" of P3, enter the name associated with the phone number or other descriptive text (optional, but helpful).
6. Click on "Apply" and "Save".

You can now speed dial the number 9175551784 by pressing key P3 on the phone.

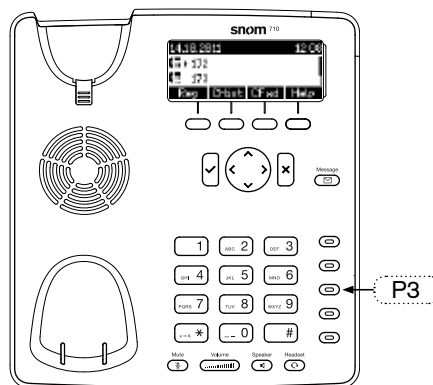

### Example 4, Turning forwarding of all calls on and off

The functionality "Forward all" redirects all incoming calls to another phone or a mailbox. It is possible to configure the settings on the phone and on the web interface. If you use this function frequently and/or regularly, you may want to be able to turn it on and off with the touch of just one key instead of going through the menu every time.

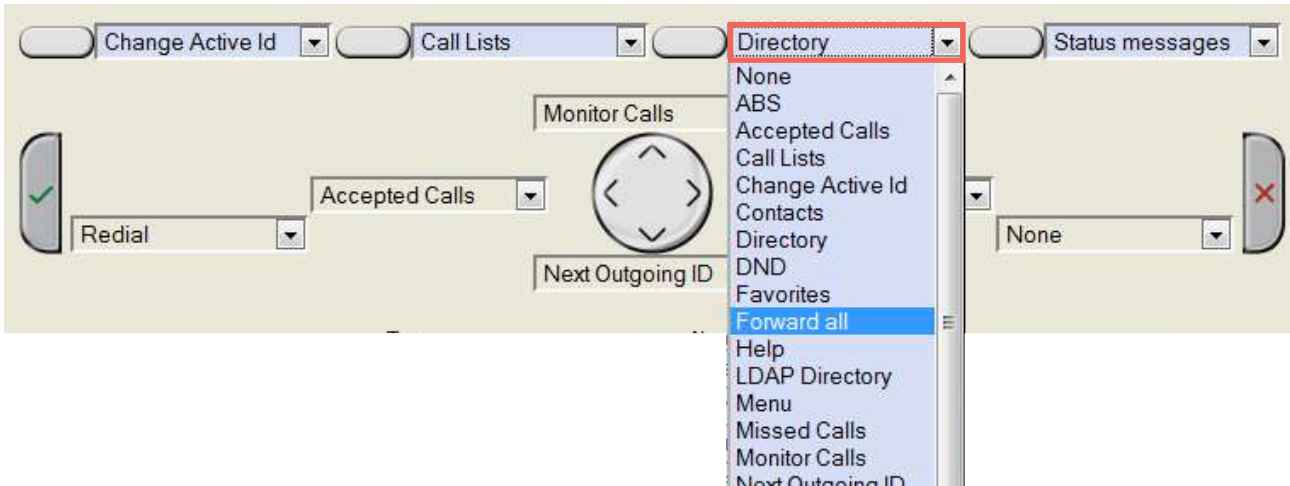

1. On the phone's web interface, click on "Function Keys" in the menu on the left.
2. Click on the drop-down list of one of the context-sensitive, programmable function keys. In our example, it is the second key from the right.
3. Select "Forward all" from the drop-down list.
4. Click on "Apply" and "Save".

Using the configured context-sensitive function key on the phone to turn forwarding of all calls on and off:

1. Press the key (Fig. 1).
2. The display will prompt you to enter a forwarding target (Fig. 2). If one has already been set, the display will propose that number; you can accept it with ✓ or change it and then press ✓.
3. To turn off forwarding of all calls, press the key again (Fig. 3).

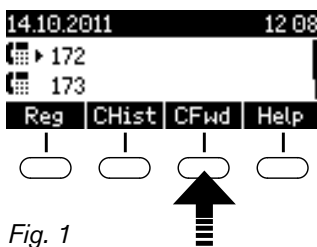

Fig. 1

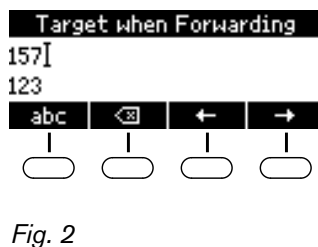

Fig. 2

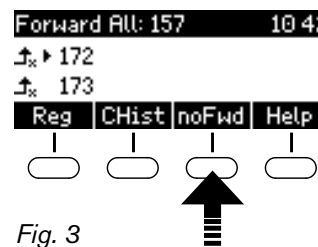

Fig. 3

## Customizing the phone settings

See "The phone's web interface" on page 29 on how to open the phone's web interface and on the mechanics of navigating in the windows and changing the settings. See "User mode/administrator mode" on page 32 for an explanation of administrator and user mode.

Any changes you make will not take effect until you press "Apply" and "Save". Changes will be lost if you open another page of the web interface without first pressing "Apply"/"Save".

If you have access to administrator mode, but do not consider yourself to be an expert on SIP and SIP phones, we recommend that you do not change any of the technical settings since this may adversely affect the phone's performance or put it out of order altogether.

If you want more information on a web interface setting, click on the radio button with the question mark that you see to the right of each item. It links to a page on snom's Wiki with detailed information about that particular item.







On customizing the function key settings, see the chapter "Configuring the function keys" on page 56.

**Note:** Any changes you make on the web interface will not take effect until you click on "Apply" and "Save". Changes will be lost if you open another page or tab of the web interface or if you close the web interface without first clicking on "Apply" and "Save".

## Adjusting the display

### Contrast

Increasing and decreasing display contrast:

1. Press **Settin**.
2. Press 1 Preferences.
3. Press 5 Display.
4. Press 1 Contrast.
5. Press the right ( / ) or left ( / ) arrow (function key or navigation key) to increase () or decrease () the display's contrast.



### Backlight

Lowering backlight intensity lowers the energy consumption of the phone. The available settings are on, off, and always. The settings "always" and "off" mean that the backlight is permanently on or off.

When you select the setting "on", the backlight will dim when there has been no activity on the phone for the number of seconds specified on the phone's web interface. The default setting is 20 seconds.

Selecting the setting:

1. Press **Settin**.
2. Press 1 Preferences.
3. Press 5 Display.
4. Press 2 Backlight.
5. Press the right ( / ) or left ( / ) arrow (function key or navigation key) to switch between the settings.



Changing the number of seconds after which the phone will dim the backlight to the idle screen setting (applicable to backlight setting "on" only):

1. Open the phone's web interface (see "Opening the web interface" on page 30).
2. Click on "Preferences" (see "How the web interface works" on page 31).
3. Enter the number of seconds in the text field of "Dim after (in seconds)" (in the section "General Information". default is 20 seconds).
4. Click on "Apply" and "Save".

## Identities/accounts

The phone supports up to four accounts or "phone numbers" with one or more providers or within an office or organization network. On snom phones these accounts or phone numbers are called "identities".

If your phone is part of an office network, you may need to contact your administrator to configure new or change existing identities, as this can only be done when the phone is running in administrator mode and when the PBX settings allow it.

See "Initializing and registering the phone" on page 15 for the information on required input data.

### Configuring new identity/account

#### On the phone

You can do the basic setup (account/number & registrar) on the phone:

1. Press **Settin** > 3 Identity > 3 Edit User.
2. Press ▼ to scroll down.

- When you are at the top of the list, pressing ▲ on the navigation key will take you to identity 4.
  - At any other position within the list, press ▼▲ to scroll.
3. Press ✓ to select.
  4. When prompted, enter Account and Registrar.
  5. Press ✓.

## On the web interface

Open the web interface and click on an identity in the menu on the left. The configuration window for that identity will open; it contains four tabs, with the left one, Login, visible in the front.

1. **Login tab.** Enter the information received from your provider or your administrator in the appropriate fields.
  - Display name

The display name is optional and freely selectable. It will be sent to any parties you call unless you hide your identity (see "Hide my caller ID" on page 73). If you do not enter a display name, the data in the "Account" text field will be shown on your display and sent to any parties you call unless you hide your identity.
  - Display text for idle screen

Any text you enter in in this text field will be shown - instead of your display name or account - on your display only. It will not be sent to any parties you call.
  - Ringtones

The phone has 10 built-in ringtones that can be assigned to identities, group types, and contact types. It is also possible to download a custom melody and to turn off the ringer by selecting "Silent".

Assigning ringtones to identities: See "Assigning ringtones to identities" on page 65.

Assigning ringtones to contact type VIP and group types: See "Ringtones" on page 35.

**Note:** Ringers assigned to the contact type VIP and to any of the group types override the ringers assigned to identities. For example, if you have assigned Ringer 1 to one of the identities and Ringer 2 to the group "Colleagues", the phone will play Ringer 2 when a contact from the "Colleagues" group calls that identity.
2. **SIP settings.** Click on the SIP tab to bring that page to the front.
  - Automatic acceptance of incoming calls: Identity # > SIP tab > Auto Answer. The default setting is "off". Incoming calls will be answered by the phone automatically when it is not busy.
  - Acoustic alert (one short beep) when the phone accepts a call automatically: Preferences > Auto Answer > Auto Answer Indication. The default setting is "off".
  - Contact List. A contact list must be available on a server. Click "on" and enter the Contact List URI.



## Editing an existing identity/account

### On the phone

You can edit the account/number and the registrar only:

1. Press **Settin** > 3 Identity > 3 Edit User.
2. Press ▼ to scroll down.
  - When you are at the top of the list, pressing ▲ on the navigation key will take you to identity 4.
  - At any other position within the list, press ▼▲ to scroll.
3. Press ✓ to open the selected identity.
4. When prompted, enter Account and Registrar.
5. Press ✓.

### On the web interface

Open the Configuration page of the identity and make the changes in the text fields. See "Configuring new identity/account", section "On the web interface" on page 64 for more information.

If you have changed the account or the registrar, click on "Re-Register" and "Save". If you have made other changes, clicking on "Apply" and "Save" suffices.

## Assigning ringtones to identities

The phone has 10 built-in ringtones that can be assigned to identities, group types, and contact types. It is also possible to download a custom melody. When an incoming call to an identity is ringing, the phone will play the ringtone assigned to that identity, unless it is a call from a VIP or a group with a distinctive ringer of their own.

**Assigning ringtones to contact type VIP and group types:** See "Directories" on page 65.

**Note:** Ringers assigned to the contact type VIP and to any of the group types override the ringers assigned to identities. For example, if you have assigned Ringer 1 to one of the identities and Ringer 2 to the group "Colleagues", the phone will play Ringer 2 when a contact from the "Colleagues" group calls that identity.

If your ringtones don't seem to work as expected, contact your administrator. There may be an overriding setting on the PBX.

### Selecting identity ringtones:

- **On the phone:** 1 Preferences > 3 Ringer. The identities are shown on the display.
  - Select an identity with ▲ / ▼ and press ✓ to hear the current ringtone for that identity.
  - Selecting a different ringtone: Press ▲ / ▼ to navigate up and down the list. The marked ringtone is played. Press ✓ to select the currently marked ringtone for the currently selected identity.
  - Press ✕.

- **On the web interface** (the ringtones will be played by the phone): Configuration Identity (1-4) > Login.
  - Click on "Play Ringer" to play the currently selected ringer.
  - To change the ringer, select a ringer from 1 to 10 in the drop-down menu of "Ringtone". If you have selected the custom melody, enter the URL to the data file in the text field underneath. It must be a file of the type PCM 8 kHz 16 bit/sample (linear) mono WAV.
  - Click on "Apply" and "Save".

## Time and date formats

The date and time formats can be set and changed on the web interface only.

### Time

The time setting affects phones and/or firmware versions with a digital clock only. If the phone has a clock face, changing the setting will not affect it.

1. Open Preferences > General Information > 24 Hour Clock. The default is "on".
  - Select "on" to have the time on the phone's display shown in 24-hour format, 00:01 to 24:00 .
  - Select "off" to have the time on the phone's display shown in AM/PM format, 0:01 AM to 12:00 PM.
2. Click on "Apply" and "Save".

### Date

1. Open Preferences > General Information > US Date Format. The default is "on".
  - Select "on" to have the date shown on the phone's display in "m/d/yyyy" or "mm/dd/yyyy" format. Examples: May 6 will be displayed as 5/6; December 10 will be displayed as 12/10.
  - Select "off" to have the date shown on the phone's display in "d.m.yyyy" or "dd.mm.yyyy" format. Examples: May 6 will be displayed as 6.5; December 10 will be displayed as 10.12.

| Date              | US Date Format setting |            |
|-------------------|------------------------|------------|
|                   | On                     | Off        |
| March 5, 2012     | 3/5/2012               | 5.3.2012   |
| March 12, 2012    | 3/12/2012              | 12.3.2012  |
| December 5, 2011  | 12/5/2011              | 5.12.2011  |
| December 10, 2011 | 12/10/2011             | 10.12.2011 |

2. Click on "Apply" and "Save".

## Time and date settings

See Time zone.

### Time zone

The phone receives the time and date from your NTP time server. If the time and/or date on the display are incorrect, you may need to set the correct time zone. If you have set the correct time zone and the time is still incorrect, there may be a problem with the time server. Contact your network administrator or your IP provider.

The list of time zones is arranged by the difference in hours (+/-) to the UTC and, within each time zone, alphabetically by selected locations (country or country and city). The time zone can be selected and set on the phone as well as on the web interface.

### Setting on the phone

1. Press **Settin** > 1 Preferences > 1 Time Zone.
  - Press **Reduc** to collapse the list to show only selected times zones where the phone language is spoken.
  - Press **More** to show all time zones.
  - Press **Jump** to fast-forward to the beginning of the next time zone, i.e., UTC +1, +2, etc.
  - Use **▲▼** to scroll.
2. Press **✓** to save your selection
3. Press **X** for two secondc to return to the idle screen.

### Setting on the web interface

This setting can be accessed in administrator mode only.

1. Open Advanced > Network tab > Time > Timezone.
2. Select your timezone/country/city from the drop-down list.
3. Click on "Apply" and "Save".

## Language settings of phone and web interface

The language used on the phone can be changed on the phone as well as on the web interface. The language used on the web interface can be changed on the web interface only.

### Phone language

#### Setting on the phone

1. Press **Settin** > 1 Preferences > 4 Language.
2. Use ▲▼ to scroll.
3. Press ✓ to save the selected language.
4. Press ✕ for two seconds to return to the idle screen.

#### Setting on the web interface

1. Open Preferences > General Information > Language.
2. Select the language from the drop-down list.
3. Click on "Apply" and "Save".

### Web interface language

1. Open Preferences > General Information > Webinterface language.
2. Select the language from the drop-down list.
3. Click on "Apply" and "Save".

## Dial tones

Different dial tones for different countries! Select yours on the phone or on the web interface.

### Setting on the phone

1. Press **Settin** > 1 Preferences > 2 Tone Scheme.
2. Use ▲▼ to scroll.
3. Press ✓ to save the selected country.
4. Press ✕ for two seconds to return to the idle screen.

### Setting on the web interface

1. Open Preferences > General Information > Tone Scheme.
2. Select the country from the drop-down list.

3. Click on "Apply" and "Save".
4. Press ✓ to save your selection
5. Press X for two seconds to return to the idle screen.

## Music on hold

As of firmware version 8.7.3.8 firmware downloads include a music on hold (MoH) that is saved locally on the phone. The default setting for playing music to callers on hold is "off".

- Enabling MoH:
  1. Open the **Advanced** page of the phone's web interface.
  2. Click on the **Audio** tab.
  3. Change the setting of **Play music during hold** to "on".
  4. Click on "Apply" and "Save".
- You can replace the MoH provided by snom with a customized, either during firmware or separately, as described below. In this case, please **keep in mind**:

**Music - the musical composition itself as well as audio recordings - is covered by copyright laws; their use in the form of MoH is subject to licensing fees in most countries. It is your responsibility to comply with the laws and terms of copyright in your country!**

The MoH (mono, sample rate 8000Hz) consists of simple RTP packets (without header, Codec G711u (*uncompressed raw headerless pcmu file*)) which are stored in the applications directory in a file called *moh.wav*. To replace the stored music, proceed as follows:

1. Convert your music to the format "*uncompressed raw headerless pcmu file*" with an audio editor; there are some free audio editors available, for example Audacity and Free Audio Editor (as of September 2012). The size of the file will be checked by the software. It must not exceed the following maximums:

3xx phones: 128 kB

7xx- und 8xx-Telefone: 1 Mb

2. Save your music on a TFTP server.
3. Save an XML file with the URL to the TFTP server on a web server. Example (don't forget to replace the fictional IP address by the actual one!):

```
<?xml version="1.0" encoding="utf-8" ?>
<uploads>
<file url="tftp://192.168.11.18/moh.wav" type="moh" />
</uploads>
```

4. Open the **Advanced** page of the phone's web interface.
5. Click on the **Update** tab.
6. Enter the URL of the XML file in the text field of **Setting URL** and click on **Apply**.  
Example: `http://192.168.11.18/prov/upload_tmp.xml`

The XML file will be read during the next reboot, and the file stored on the phone will be replaced by the file stored on the TFTP server.

7. You should now reenter your usual provisioning server into the text field of **Setting URL**.

## Streaming MoH from media server

If you have a music-on-hold account on a media server and want to stream the audio data to the held calls of one of the phone's identities, you have to configure the settings of the identity on the phone's web interface accordingly:

1. Open the page **Configuration Identity #**.
2. Click on the **SIP** tab.
3. Type the SIP URI of the account on the media server into the text field of **Music on hold server**. Examples for valid values: <sip:mh@snom.de>, <mh>, <192.168.0.40>.
4. Click on **Apply**.

Please **keep in mind**:

**Music - the musical composition itself as well as audio recordings - is covered by copyright laws; their use in the form of MoH is subject to licensing fees in most countries. It is your responsibility to comply with the laws and terms of copyright in your country!**

## Emergency numbers

These are numbers that can be dialed even when the keyboard is locked. They must be set beforehand on the web interface.

1. Open Preferences > Lock Keyboard > Emergency Numbers (space separated).
2. Enter the emergency numbers in the text field. Type each number without spaces between the digits, separate the individual numbers with one empty space between them.  
Example: If you want to set the emergency phone number 911 and the phone numbers of your doctor (986543) and a friend (234578), the entry would look this: 911 986543 234578.
3. Click on "Apply" and "Save".

## Call forwarding

This feature automatically redirects all or certain incoming calls to another phone or a mailbox. It is possible to configure the settings on the phone and on the web interface.

### Always

All incoming calls are forwarded to the number of the phone, extension, or mailbox specified as this function's target.

### When busy

Calls ringing while the phone is busy are forwarded to the number of the phone, extension, or mailbox specified as this function's target.

## After timeout

When a call starts ringing, the phone will wait for the number of seconds specified as "call forwarding time". If the call has not been accepted by the end of this time period, it is forwarded to the number of the phone, extension, or mailbox specified as this function's target.

## Configuring the settings on the phone

See "Call forwarding" on page 53.

## Configuring the settings on the web interface

If your internet telephony provider or your PBX uses codes to turn functions on and off, refer to their manuals for the codes to enter in the "On Code"/"Off Code" text fields or ask your administrator.

### Setting forwarding numbers

- Forwarding all incoming calls:
  1. Open Preferences > Call Forwarding > Always.
  2. Type the phone number in the "Target" text field. Type each number the way it needs to be dialed by the phone, without spaces or punctuation between the digits.
  3. Click on "Apply" and "Save".
- Forwarding incoming calls when the phone is busy:
  1. Open Preferences > Call Forwarding > Busy.
  2. Type the phone number in the "Target" text field. Type each number the way it needs to be dialed by the phone, without spaces or punctuation between the digits.
  3. Click on "Apply" and "Save".
- Forwarding incoming calls when they are not answered:
  1. Open Preferences > Call Forwarding > Timeout.
  2. Type the phone number in the "Target" text field. Type each number the way it needs to be dialed by the phone, without spaces or punctuation between the digits.
  3. Click on "Apply" and "Save".

### Turning call forwarding on

1. Web interface > Preferences > Call Forwarding.
2. Click "On" after the forwarding event ("Always", "Busy", "Timeout").
3. Click on "Apply" and "Save".

## Turning call forwarding off

1. Web interface > Preferences > Call Forwarding.
2. Click "Off" after the forwarding event ("Always", "Busy", "Timeout").
3. Click on "Apply" and "Save".

## Call completion

On snom phones call completion means that when a called number is busy or not available, your phone will call you back as soon as the dialed number is not busy anymore or available again. The factory default setting is "off". See "Call completion" on page 44 on how to use this feature.

**Note:** This function depends on whether it is available in your network or not.

Changing the setting to turn it on:

### On the phone

1. Press **Settin** > 2 Call Features > 2 Outgoing Calls.
2. Press "3  Call Completion" to change to "3  Call Completion".
3. Press **X** for 2 seconds to return to the idle screen.

### On the web interface

1. Web interface > Advanced > Behavior > Phone Behavior > Call Completion.
2. Click "On".
3. Click on "Apply" and "Save".

## Call waiting

When you are in a call, another incoming call will be announced visually by the **+**  symbol and acoustically by the sound of a double beep; you will also see caller ID on-screen if it is being transmitted. Switch to visual or acoustic announcement only or turn call waiting off on the phone's web interface.

The default setting is "on", which means that calls are announced both acoustically and visually. See "Call waiting" on page 50 on how to use this feature.



*Single call waiting*



*More than one call waiting*



1. Open Advanced > Audio > Call Waiting Indication.
2. To turn call waiting off, select "off" from the drop-down menu. Select "visual only" or "ringer" if you want waiting calls announced only by the "phone ringing" symbol or the double beep, respectively.
3. Click on "Apply" and "Save".

## Hide my caller ID

With this setting your phone number will not be transmitted to any phones you call. Please note that your call may not be accepted if the other phone is set to reject anonymous calls (see next item).

1. Open Preferences > Privacy Settings > Suppress own number (CLIP/CLIR).
2. Select the radio button "Hide".
3. Click on "Apply" and "Save".

## Do not disturb mode

With this setting, incoming calls will not ring on your phone; callers hear the busy signal.

**Exception:** Phone numbers on your directory's VIP list (see Contact Types)

To make this functionality available on your phone, you have to map the DND key event either onto one of the context-sensitive function keys underneath the display or onto one of the freely programmable function keys. For more information, see "Programming the function keys" on page 57.

To turn DND on and off, press the mapped function key. When DND is on, the display will say "DND activated", and the DND symbol  replaces the phone symbol that normally precedes the identity.



## Reject anonymous calls

With this setting you will not receive calls from phones whose number is not shown on your display. Anonymous callers will hear the busy signal.

Please note that calls from analog phone connections will, most likely, be received as anonymous calls.

1. Open Preferences > Privacy Settings > Reject incoming anonymous calls.
2. Select the radio button "Reject".
3. Click on "Apply" and "Save".

## Number guessing

When you have typed the minimum number of characters you have specified for this function, the phone will look for numbers containing that string of characters in its call lists and directories and, if it finds matches, show the number(s) on the display. If the number proposed on the display is the one you wish to dial, press ✓ (Fig. A and B); if not, continue entering digits (Fig. C).



Fig. A

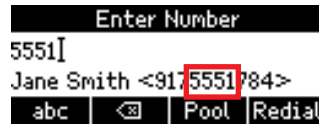

Fig. B



Fig. C

The default setting is off. Changing the setting:

1. Open Advanced > Behavior tab > Phone Behavior > Number Guessing.
2. Select the radio button "on".
3. Type the minimum number of digits in the text field of "Number Guessing Minimum Length".
4. Click on "Apply" and "Save".

## Speed dial

You can use the numbers 0 to 30 and the special characters # and \* to speed dial frequently and/or long numbers without having to enter the complete phone number. The numbers must be set on the phone's web interface first:

1. Open Setup > Speed Dial.
2. Enter one phone number with any required prefixes (area code, country code, operator/auto attendant, etc.) in the text field for each respective number or special character.

**Note:** Type each phone number without spaces or punctuation between the digits.

For example: You want to be able to speed dial the phone number 555-1784 in area code 917 by pressing the  key. In conventional notation you might write the number down as (917) 555-1784. In the speed dial table, type 9175551784 into the text field of the number 1.

If you want to add a name or other data before or after the number, type the number in angled brackets <>. Example: Accounting <9175551784>.

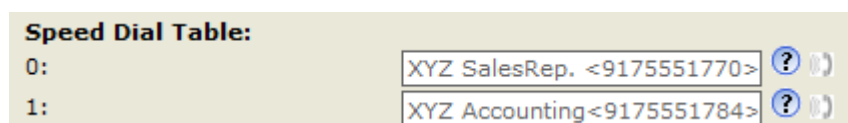

3. Click on "Apply" and "Save". You can now speed dial the number by pressing  and ✓ on the phone.

# Software update

## Manual update

1. Open snom's web page at [www.snom.com](http://www.snom.com).
2. Click on Support > Download > Firmware.
3. Click on the phone to be updated.
4. Click on the firmware version currently running on your phone.
5. Click on the firmware version you want to update to.
6. Right-click on the version's link and copy it.
7. Open the phone's web interface > Setup > Software Update.
8. In the Manual Software Update area, paste the link into the text field behind Firmware.
9. Click on Load. The phone begins to reboot.
10. If the phone asks "Reboot?", press ✓.
11. DO NOT DISCONNECT THE POWER WHILE THE PHONE IS REBOOTING!

## Auto provisioning

See our web page [http://wiki.snom.com/Features/Mass\\_Deployment](http://wiki.snom.com/Features/Mass_Deployment) for information.

1. Open the phone's web interface > Setup > Advanced > Update tab.
2. Please read the instructions at "?" of each line carefully.

# Troubleshooting

## Reboot

1. Press **Settin**.
2. Press 5 Maintenance.
3. Press 3 Reboot.
4. When asked whether to "Reboot?", press ✓.
5. Wait for the idle screen to reappear.

## Hard reboot

Disconnect the power, wait for a few seconds, and reconnect. Wait for the idle screen to reappear.

**Warning:** Never disconnect the power during a firmware update!

## Reset to factory values

1. Press **Settin**.
2. Press 5 Maintenance.
3. Press 4 Reset values.
4. Enter the administrator password and press ✓.
5. Wait for the idle screen to reappear.
6. See "Initializing and registering the phone" on page 74 to continue.

**Warning:** All customized settings will be lost!

## TFTP Update

When there is no other way to get the phone to work (administrator password lost, etc.). How it is done: See [http://wiki.snom.com/Firmware/Update/TFTP\\_Update/en](http://wiki.snom.com/Firmware/Update/TFTP_Update/en).

**Warning:** All customized settings will be lost!

## Manual initialization

When automatic initialization via DHCP fails, enter the values for netmask, IP gateway, and DNS server manually after each prompt on the display.

## Contacting snom Support

Please visit our knowledge base and our forum first. You may find the answer to your question in one of the topics there. If you haven't found an answer or a solution to your problem, please post your question or problem on the forum (<http://forum.snom.com>).

**Note:** The forum is accessible to the general public. Do not post any private and/or security-relevant information there. This includes MAC addresses, SIP headers, etc. that may allow others to hack into your system or use your identity for nefarious purposes.

If you haven't received an answer or solution within a reasonable amount of time (generally two work days), send the link to your posting to Support. You need to create a support account first, if you don't already have one.

### Creating a support account

1. Open snom's web page at [www.snom.com](http://www.snom.com).
2. Click on the Support tab to open the Support window.
3. Click on End Customer Support.
4. On the Support Center page, click on Register new account.
5. Fill out the form and click Register.
6. You will receive an automatic email. Click on the link to activate your account.
7. You will receive a second email containing your account name, email address, and password.

You can now submit tickets requesting support to snom Support.

### Submitting a ticket

1. Open snom's web page at [www.snom.com](http://www.snom.com).
2. Click on the Support tab to open the Support window.
3. Click on End Customer Support.
4. On the Support Center page, enter your email address and password and click on Login.
5. Click on "Ask for support".
6. Follow the instructions on the screen.

### Submitting system and settings information

#### System information

1. Open the phone's web interface > Status > System Information.
2. Copy the text under System Information into your forum posting or into the email, if Support has asked you to contact them by email.

Make sure to delete the MAC address and the IP address, if the posting or e-mail can be read by the public.

## System information

Open the phone's web interface > Status > Settings. Make sure to delete private and/or security-relevant information like the MAC address, public IP address, etc.

## Traces

snom Support may ask you to submit a SIP Trace and/or a PCAP Trace to help them analyze your problem.

### Performing a SIP Trace

1. Open the phone's web interface > Status > SIP Trace.
2. Click on "Clear" to clear the page.
3. Recreate the error to be documented in the trace.
4. Click on "Reload".
5. Copy the text and submit to Support in whatever form they requested you to use.

### Performing a PCAP Trace

1. Open the phone's web interface > Status > PCAP Trace.
2. Click on "Start" to start recording network traffic.
3. Click on Stop to end recording.
4. Click on the "here" link to open the file download window and save the file.
5. Submit the file to Support in whatever way they requested you to use.

# Display symbols and Icons

## Symbols found in the function key line

The buttons symbolize the functions that are currently available for activation. Press the function key underneath the symbol to activate the function.











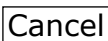
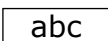

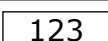

### Programmable function symbols

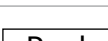
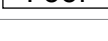
These are the symbols displayed in the function key line when the phone is idle. They can be selected on the phone's web interface > Function Keys page. See .. for the default settings.

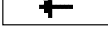
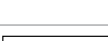
|  |  |
|--|--|
| <input type="button" value="Reg"/>         | Displaying SIP URLs of all active identities; selecting outgoing identity  |
| <input type="button" value="CHist"/>       | Call list menu (missed, received, and dialed calls)  |
| <input type="button" value="Info"/>        | Currently available status messages  |
| <input type="button" value="DND"/>         | Turning DND on and off   |
| <input type="button" value="Contac"/>      | Contacts list  |
| <input type="button" value="CFwd"/> /NoFwd | Forwarding all calls (turning on/turning off)  |
| <input type="button" value="Presen"/>      | Allowing presence signaling  |
| <input type="button" value="Retr."/>       | Retrieving messages from mailbox   |
| <input type="button" value="Settin"/>      | Settings menu  |
| <input type="button" value="Dir."/>        | Directory  |
| <input type="button" value="Calls"/>       | Monitoring calls on other extensions (see Extension Monitoring). The button will only be displayed when there are ongoing calls. |
| <input type="button" value="Help"/>        | IP address of phone and snom's web address   |
| <input type="button" value="Redial"/>      | Redial (dialed calls)  |
| <input type="button" value="A.Cal."/>      | Received calls   |
| <input type="button" value="Mis.C."/>      | Missed calls   |
| <input type="button" value="Fav."/>        | Favorites  |
| <input type="button" value="LDAP"/>        | LDAP Directory   |
| <input type="button" value="Id.v."/>       | Next outgoing ID   |
| <input type="button" value="Id."/>         | Previous outgoing ID   |
| <input type="button" value="ABS"/>         | Address book search (OCS accounts only)  |

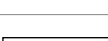

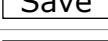
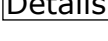

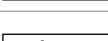
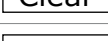
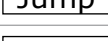
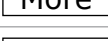
## Context-sensitive symbols

These are the symbols displayed in the function key line when the phone is active, for example when a call is ringing, when you are dialing, etc.

|   |   |
|---|---|
|    | Confirming a selection or an action   |
|    | Terminating/canceling an action and return to the previous screen   |
|    | Switching input mode to small letters   |
|    | Switching input mode to capital letters   |
|    | Switching input mode to numerals  |
|    | Deleting the character to the left of the cursor  |
|    | Moving down lists in various contexts   |
|    | Moving up lists in various contexts   |
|    | Displaying available directories, contact lists, etc.   |
|    | Sorting Directory entries   |
|   | Editing mode for selected entry in Directory  |
|  | <ul style="list-style-type: none"> <li>▪ Moving the cursor to the left when entering/editing directory entries</li> <li>▪ With more than one call on hold or waiting, press to show other callers</li> </ul>  |
|  | <ul style="list-style-type: none"> <li>▪ Moving the cursor to the right when entering/editing directory entries</li> <li>▪ With more than one call on hold or waiting, press to show other callers</li> </ul> |
|  | Deleting selected directory entry   |
|  | Adding caller's number to Directory   |
|  | Showing details of missed calls (to, from, date/time, total number) and of received and dialed calls (to, from, date/time, duration)  |
|  | Returning to call list  |
|  | Deleting selected call list entry   |
|  | Deleting entire call list   |
|  | Moving to beginning of next time zone   |
|  | Expanding the list of time zones to show all  |
|  | Collapsing the list of time zones to show only time zones relevant to the language setting (i.e., countries where the language is spoken)   |
|  | Last numbers dialed. Redial selected number (preceded by ►)   |
|  | Establishing conference between calls on hold and yourself  |
|  | Putting conference participants on hold   |

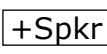

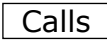





## Appendix 1 - Display Symbols



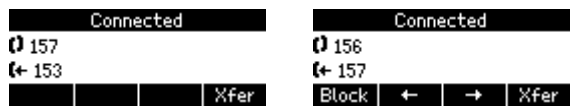

|   |   |
|---|---|
|  | Call transfer   |
|  | Turning on the casing speaker   |
|  | Turning off the casing speaker  |
|  | On active screen (i.e., in call etc.): Monitoring calls on other extensions (see Extension Monitoring). The button will only be displayed when there are ongoing calls. Press to show details of calls on monitored extensions. |
|  | Available status messages like firmware update available, reboot required, call completion pending, call forward activated, etc.  |

## Display indications

### On activity

|   |   |  |
|---|---|--|
|    | First line in context area:<br>Incoming call ringing  |    |
|   | Connected (single connection or conference)   |  |
|  | Second line in context area:<br>Call waiting. If there is more than one call waiting, view and select with ← / →. |  |
|  | Call(s) on hold   |  |

### On idle screen

|   |   |
|---|---|
|  | <p><b>Outgoing identity</b></p> <ul style="list-style-type: none"> <li>The current outgoing identity is indicated by the right arrow pointing towards it:  172. When you call someone, this is your identity for the call.</li> <li>Select a different identity for the next call by pressing ▲▼ on the navigation key.</li> </ul> |
|  | <p><b>Active identity</b></p> <ul style="list-style-type: none"> <li>Can be called</li> <li>Can be selected as the outgoing identity for making calls by pressing ▲▼ on the navigation key.</li> </ul>  |
|  | Identity not properly registered.   |

## Appendix 2 - Status messages

Whenever there is a current message concerning the status of the phone, the function key **Info** will be available. Press the function key (or **Settin** > 6 Information > 1 Status Info) to open the "Status info" screen. Additionally, some status messages will also be displayed in the status bar; if there is more than one current message, the one with the highest priority will be shown. The messages in descending order of priority:

| Status message   | Definition  |
|--|---|
| SW <sup>1</sup>  | A firmware update is available  |
| Reboot required <sup>1</sup>                           | Reboot required, for example to have settings changes take effect   |
| SIP disabled <sup>1,2</sup>                            | The phone cannot make calls due to license problems   |
| Error <sup>1</sup>                                     | An error occurred   |
| Low memory <sup>1</sup>                                | Disk space full   |
| Remote directory is too big <sup>1</sup>               | The remote directory is too big to be imported  |
| Not Registered: <account> <sup>1,2</sup>               | The specified identity/account is not registered  |
| Waiting for <name/number> to be available <sup>2</sup> | Waiting for call completion to busy or currently unavailable number   |
| <account> is now available <sup>2</sup>                | The dialed number is not busy anymore or is now available   |
| Forward when Busy: <name/number>                       | Call forwarding is on. When your phone is busy, incoming calls will be forwarded to the phone number indicated  |
| Forward after Timeout: <name/number>                   | Call forwarding is on. When an incoming call is not picked up within the set number of seconds, the call will be forwarded to the phone number indicated                        |
| Forward all: <name/number> <sup>2</sup>                | Forwarding of all incoming calls is on. All incoming calls will be forwarded to the phone number indicated.   |
| Contacting NTP server                                  | Network Time Protocol (NTP) is a protocol for synchronizing clocks over data network. If the connection is interrupted, the phone will not be able to display the correct time. |
| NTP server unreachable <sup>1</sup>                    |   |
| HTTP Password not set <sup>1</sup>                     | No HTTP password has been set   |
| Admin Password not set <sup>1</sup>                    | No Admin password has been set  |
| Keyboard locked <sup>2</sup>                           | Only numbers designated as emergency numbers can be dialled   |
| DND active <sup>2</sup>                                | Do not Disturb mode is activated  |
| You have messages                                      | There are spoken messages on the mailbox  |
| You have new messages                                  | New (messages on the mailbox)   |
| Old messages   | Old (messages on the mailbox)   |
| Missed: <number>                                       | The number of calls you missed since the last time you checked the list of missed calls or turned off the missed call indication  |

<sup>1</sup> The function key **Info** will be blinking

<sup>2</sup> The message cannot be deleted from the "Status Info" screen

# Wall Mounting

Not included in the delivery are the two screws (diameter of head between 6 and 9 mm, diameter of body max. 4.5 mm) and two screw anchors/molly bolts/wall plugs appropriate for your type of wall.

1. Anchor the screws in the wall, using the measurements given in Fig. 1 and Fig. 2.
2. Unscrew the slide guides for the footstand from the back of the phone (Fig. 3).
3. Plug the long end of the handset cord into the connector labelled " " on the back of the phone and place the cord in the cable guide (Fig. 4).
4. Hang the phone on the screws by placing the holes on the back of the phone over them (Fig. 5).

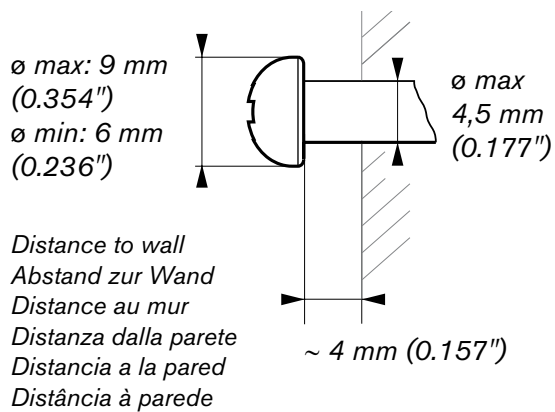

Fig. 1

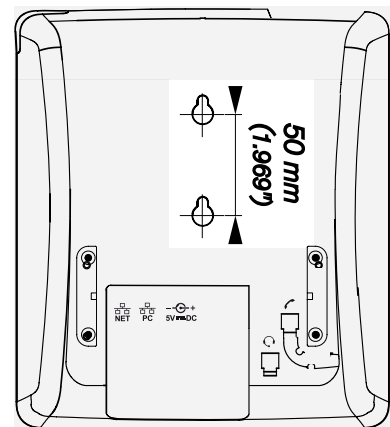

Fig. 2

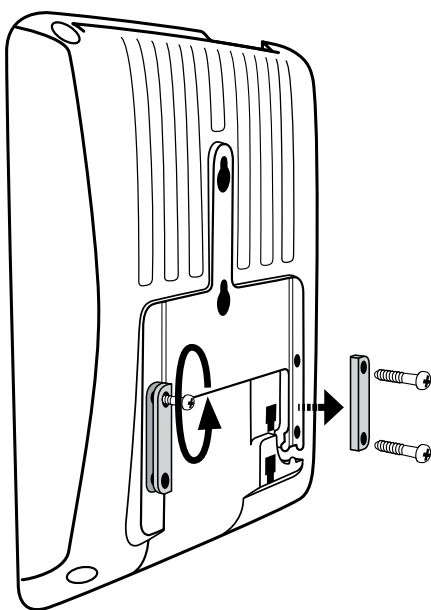

Fig. 3

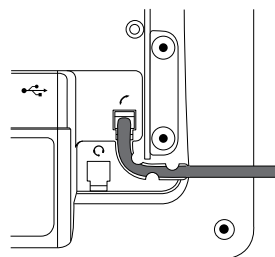

Fig. 4

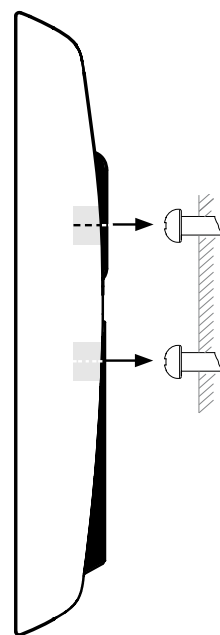

Fig. 5

## Programmable functions

Following is a brief description of the function key settings available on the "Function keys" page of the phone's web interface.

|                             |  |
|-----------------------------|--|
| Action URL                  | Action URLs are basically HTTP GET Requests that allow the phone to interact with web server applications. They can be used to send various data from the phone to a web server, like the customized settings stored on the phone; passwords are replaced by empty strings. Action URLs can be triggered by predefined events ("Action URL Settings" page of the phone's web interface) or manually by a pressing a function key that has been programmed to trigger an action.  |
| Auto Answer                 | With this setting, your phone will automatically accept incoming calls when it is idle. If you leave the text field empty, incoming calls for all configured identities will be accepted; if you enter the number of an identity in the text field, only calls to that identity will be accepted automatically (i.e., 1 for Identity 1, 2 for Identity 2 etc.).  |
| BLF<br>(Busy Lamp<br>Field) | This function key allows showing the status (idle, ringing, held call, busy) of another extension on the key's LED. By pressing the key, it may also be possible to pick up calls ringing on the extension, to dial the extension when the phone is idle, and to transfer an incoming call ringing on your own extension. These functionalities depend on your PBX; for more information, please check snom's interoperability page and the PBX manual. With Asterisk, generally use this feature rather than extension.   |
| Button                      | This is a function key that is connected to your PBX to perform a task specified in the buttons document. For more information, see the detailed feature description at <a href="http://wiki.snom.com/Features/LED_Remote_Control">http://wiki.snom.com/Features/LED_Remote_Control</a> .  |
| Call Agent                  | This function key can be used by call agents to perform one of three different functions, depending on the value entered in the "Number" text field: <ul style="list-style-type: none"> <li>▪ Logging onto and off the system.<br/>Text field entry: F_CALL_AGENT_LOGGEDIN.</li> <li>▪ Signaling readiness to accept calls. For this function to work, the agent must be logged in. Text field entry: F_CALL_AGENT_READY.</li> <li>▪ Announcing that they are working after a call. For this function to work, the agent must be logged in.<br/>Text field entry: F_CALL_AGENT_WORKINGAFTERCALL.</li> </ul>  |
| Conference<br>Server        | This function key can be used for PBX-based conferences and for local conferences on the phone itself. <ul style="list-style-type: none"> <li>▪ PBX-based conferences. When a conference room or conference account has been created on the server for an individual identity, you can dedicate a function key to calling and monitoring the conference room. Select the identity and the "Conference server" function from the respective drop-down menus and enter the SIP URI of the conference room in the "Number" text field. For information on how to use this key with your particular PBX, please check the PBX manual.</li> <li>▪ Phone-based conferences. If there is no SIP URI in the text field, pressing the function key will initiate a phone-based conference with all held calls and any active call.</li> </ul> |



## Appendix 4 - Programmable Functions

|            |  |
|------------|--|
| DTMF       | This function allows the specification of arbitrary key sequences (allowed digits: "0-9", "*", "#", "A-D" and flash: "!") which will be sent via DTMF when this key is pressed during an active call.  |
| Extension  | This function key allows showing the status (idle, ringing, held call, busy) of another extension on the key's LED. By pressing the key, it may also be possible to pick up calls ringing on the extension, to dial the extension when the phone is idle, and to transfer an incoming call ringing on your own extension. These functionalities depend on your PBX; for more information, please check snom's interoperability page and the PBX manual. With Asterisk, generally use BLF rather than this function.  |
| Forward to | All incoming calls will be forwarded to the number (extension or external phone number) specified under "Number". The key is used to turn forwarding of all calls on and off; the red LED lights up when the function is turned on.  |
| Intercom   | Pressing a function key mapped with "Intercom" will establish a two-way connection to the extension specified in the "Number" text field; that extension must have enabled intercom reception on its web interface ( <b>Advanced Settings &gt; Behavior tab &gt; Phone Behavior &gt; Intercom Policy</b> "only in idle" or "always").  |
| IVR        | <p>This function key can be used for regular calls to an extension that is reached via an IVR or auto attendant and a number of voice prompts where the caller has to make a selection by pressing a key after or during the prompt. If you know which keys need to be pressed in which order in order to reach the desired extension, the entire process can be automated and considerably speeded up.</p> <p>The syntax for the "Number" text field entry is <code>&lt;phone_number&gt;;dtmf=&lt;n&gt;,&lt;n&gt;</code>, etc. The angle brackets <code>&lt;&gt;</code> including their content are placeholders for the variables that you must replace by the actual characters. The comma represents a pause of one second, and n represents any number key on the alphanumeric keypad.</p> <p><b>Example:</b> The number to dial is (917) 555-3814. When the connection has been established, the caller will hear three prompts. After the first prompt, he must press key 1; after the second prompt, he must press 3; and after the third prompt he must press 1 to reach the desired extension. The entry in the "Number" text field must look like this: <code>9175553814;dtmf=1,3,1</code>.</p> <p><b>Usage:</b> When the phone is in idle mode, press the key to dial the number. As soon as the connection has been established, the phone will automatically send the DTMF tones associated with the alphanumeric keys 1, 3, and 1 with a one-second pause between them.</p> <p>(If the function type "IVR" doesn't work on individual phones, try "Speed dial" with the above description.)</p> |
| Key Event  | When this key type is selected, a drop-down menu opens under "Number". For the available selections, see the following section "Key Events".   |
| Line       | <p>Default setting for all freely programmable function keys. Incoming calls will go to the first free "line" key, and outgoing calls will use the first free line key.</p> <p>Line keys can be used to make outgoing calls with the identity selected from a particular key's "Context" menu and to have incoming calls for that identity going to that particular function key. If the key is busy, the incoming call will go to the first free line key.</p>  |

## Appendix 4 - Programmable Functions

|                |   |
|----------------|---|
| Multicast Page | <p>This function key enables the phone to send multicast streams to IP multicast group addresses. The multicast IP address and port are entered in the "Number" text field in the format <i>&lt;multicast IP address&gt;:&lt;port&gt;</i> (e.g., 239.255.255.245:5555). The angle brackets <i>&lt;&gt;</i> including their content are placeholders for the variables that you must replace by the actual characters.</p> <p><b>Please note:</b> This key is for <b>sending</b> multicast streams. To <b>allow reception</b> of multicast streams, multicast support must be enabled on the phone's web interface, Advanced settings &gt; SIP/RTP tab &gt; Multicast by setting Multicast Support to "on". You must also enter the IP addresses of the multicasts you wish to receive in ascending order of priority, 10 being the highest. In case of simultaneous multicasts, the one with the highest priority at any given time will override the others.</p> |
| Park Orbit     | <p>If a park orbit has been set up on the server, a function key mapped with the Park Orbit functionality can EITHER serve to park calls on the park orbit OR to park as well as retrieve calls, depending on the type of server used. Select the server type on the Configuration Identity page of the context identity, SIP tab, from the "Server Type Support" drop-down menu. Enter the "phone number" of the Park Orbit and/or the park position in the text field of "Number", for example orbit1@my.proxy.com or 700@my.proxy.com etc.</p>   |
| Presence       | <p>If supported by your PBX, the LED of this function key will reflect the presence status (ringing, busy, available, etc.) of the extension specified in the "Number" text field. The function key can also be used to dial the extension, usually when the destination signals availability.</p>  |
| Push2Talk      | <p>Pressing the function key mapped with "Push2Talk" will establish a two-way connection to the extension specified in the "Number" text field for as long as the key is pressed; that extension must have enabled intercom reception on its web interface (<b>Advanced Settings &gt; Behavior tab &gt; Phone Behavior &gt; Intercom Policy</b> "only in idle" or "always").</p> <p>On 870 phones, this key type will establish an Intercom connection.<br/> On 820/821 phones, this key type is only available on keys P2 and P3.<br/> On 760 phones, this key type is not available on key P4.</p>  |
| Shared Line    | <p>Bridged lines (Bridged Line Appearance (BLA)) are shared by two or more users; when one of them is using the line, the others are blocked from using it. This key type makes it possible to monitor whether a shared line is busy (the LED is lit) or not (the LED is off). The URI of the shared line is set under "Number".</p>  |
| Speed Dial     | <p>Besides using the "Speed Dial" page on the web interface to program speed dial numbers, you can also put the functionality on the freely programmable function keys with LEDs to be able to speed dial frequently used and/or long numbers without having to enter the complete phone number.</p> <p>Enter one phone number with any required prefixes (area code, country code, operator/auto attendant, etc.) in the "Number" text field for any given freely programmable function key with LEDs. Example: 0019175557813.</p> <p>Or enter a partial phone number (country, area code etc.) and complete the number on the dialog screen. In this case, enter the partial number, followed by a semicolon and "number=incomplete" in the text field. Example:<br/> 001917555; number=incomplete.</p>   |

## Appendix 4 - Programmable Functions

|                |  |
|----------------|--|
| Starcode       | <p>Making SIP calls without audiovisual indication on the phone user interface (PUI).</p> <p>Examples for using this feature:</p> <ul style="list-style-type: none"> <li>▪ Controlling settings on the PBX with dedicated keys that turn PBX functions on and off. The available functions must have been set on the PBX and they must be accessible from the phone, typically by dialing a star code. Phone function keys can be dedicated to activating and deactivating call forwarding and DND mode, transferring, picking up, and parking/unparking calls, etc. Depending on the settings on your PBX, you may either have to dedicate one key each for activating and deactivating a given function or to dedicate one key for both activating and deactivating the function.</li> <li>▪ Silent alarms or emergency calls.</li> </ul> <p>If the standard behavior of this function key type does not meet your requirements, it is possible to customize it. Copy the standard XML configuration of the key from the Settings page of the phone's web user interface (WUI) and edit it to suit your needs. Then paste the edited XML into the "Number" text field and change the key's type to "Xml definition".</p> |
| Transfer to    | <p>Transferring active calls and ringing incoming calls to the number set in the "Number" text field.</p> <p>If the text field is empty, pressing the key will put the "Enter number" screen on the display. Enter the number and press  /  to complete the transfer.</p> <p>For further information, see the article "Transferring calls" in the chapter "Using the phone".</p>   |
| Voice Recorder | <p>The phone does not record the voice streams at all; they must be recorded on the PBX where a recording account must be set up. Pressing the key when the phone is idle will establish a connection between the phone and the recording account, making it possible to record spoken memos, meetings, or conferences. Pressing the key during a call will establish a three-party conference with the two phones and the recording account as participants. Please be advised that you must respect the legal restrictions of your country for recording calls with or without the participants' knowledge and permission.</p>   |
| Xml Definition | <p>Copy the XML sub tag of the action(s) you want the key to perform into the text field. The currently available settings can be found here: <a href="http://wiki.snom.com/Features/Mass_Deployment/Setting_Files/XML/XmlSubTags">http://wiki.snom.com/Features/Mass_Deployment/Setting_Files/XML/XmlSubTags</a>.</p>   |

## Key events



|                  |   |
|------------------|---|
| ABS              | Address book search (OCS accounts)                  |
| Accepted Calls   | (Accepted List) List of calls accepted on the phone |
| Call Lists       | Call history list (missed, received, dialed calls)  |
| Change active ID | List of registered SIP identities                   |
| Conference       | Starting a conference                               |

## Appendix 4 - Programmable Functions

|  |  |
|--|--|
| Contacts                                     | Contact List, where the Presence State of selected users can be seen (online, busy, offline)   |
| Directory                                    | Internal phone directory   |
| DND  | Turning "Do not disturb" function (DND) on an off. When mapped to a function key with an LED, the LED will light up when DND is turned on.   |
| Favorites                                    | Favorites list   |
| Forward all                                  | All incoming calls will be forwarded to another extension or an external phone number. After turning call forwarding on with this key, the display will prompt you to enter - or confirm/change a previously entered - forwarding number.  |
| Help   | FW versions lower than 8: Phone's IP address, MAC address, and firmware version.<br>FW 8 and higher: Phone's IP address and the URI to snom Wiki. IP address, MAC address, and firmware version can be found in Settings > 6 Information > 2 System Information.   |
| Hold   | Placing the active call on hold  |
| LDAP Directory                               | Allows the user to look up a remote directory while dialing. Once set, this pressed key will open up the Direcory Search window. If LDAP is setup, corresponding matching entries as returned by the sever will be shown. If LDAP is not used and and presence_lookup_number setting is turned on, the contact matches will be shown. The default edit mode is alphanumeric in this state.   |
| Logoff Identities                            | Caution: This option will delete all account settings!!<br>Usage: Mainly useful for call centers with frequently changing users.   |
| Menu   | Calling up the settings menu of the phone  |
| Missed Calls                                 | Missed call history list   |
| Monitor Calls<br>(not available on snom 300) | When the phone has been programmed to monitor extensions and do/allow call pickup, a key can be mapped to show the list of monitored extensions and do call pickup from the monitor.<br>FW v8.7.2 and higher: The list will show only active extensions (i.e., busy or ringing). When there is no activity on any monitored extensions, the list is empty.   |
| Mute   | Mutes/unmutes the microphone (handset, speakerphone, headset) during active call   |
| Next Outgoing ID                             | Selecting the next identity as the outgoing identity   |
| Presence State                               | Providing access to a list where the Presence state of each registered SIP Identity can be defined (online, offline, busy, invisible).   |
| Prev. Outgoing ID                            | Selecting the previous identity as the outgoing identity   |
| Reboot                                       | Rebooting the phone  |
| Record                                       | The phone does not record the voice streams at all; they must be recorded on the PBX or other external device. Pressed during a call, the key informs the PBX to start and stop the recording of the audio stream on the PBX. While the call is being recorded, the recording symbol ● will either blink on the display or be displayed, in red ●, in the status line, depending on the phone type; if the function key has an LED, the LED will be lit throughout the recording. Please be advised that you must respect the legal restrictions of your country for recording calls with or without the participants' knowledge and permission. |
| Redial                                       | Dialed call history list (last call at the top)  |



## Appendix 4 - Programmable Functions

|                 |   |
|-----------------|---|
| Retrieve        | Retrieves new mailbox messages. This key becomes active when the phone has received a message waiting indication (MWI) with a valid mailbox URI.  |
| Status Messages | Currently available status messages (see Appendix 2)  |
| Transfer        | <p>Transferring the active call or an incoming call that you do not want to pick up. See the article <b>Transferring calls</b> in the chapter <b>Using the phone</b>.</p> <p>Pressing the key will put the "Enter number" screen on the display. Enter the number and press  /  to complete the transfer.</p> |

### COPYRIGHT NOTICE AND WARRANTY DISCLAIMER

I.

Das Produkt enthält Software, die unter der GNU General Public License, Version 2, frei genutzt werden darf.

This Product contains Software applicable to GNU General Public License, Version 2 which can be used freely.

II.

Im Verhältnis zu den Lizenzgebern der Software gilt der folgende Haftungsausschluss:

Towards the licensor of this Software the following liability is disclaimed:

This program is distributed in the hope that it will be useful, but WITHOUT ANY WARRANTY; without even the implied warranty of MERCHANTABILITY or FITNESS FOR A PARTICULAR PURPOSE. See the GNU General Public License for more details.

III.

Der Lizenztext der GPL lautet wie folgt:  
The GNU General Public License is as follows:

#### GNU GENERAL PUBLIC LICENSE Version 2, June 1991

Copyright (C) 1989, 1991  
Free Software Foundation, Inc.  
59 Temple Place, Suite 330  
Boston, MA 02111-1307, USA

Everyone is permitted to copy and distribute verbatim copies of this license document, but changing it is not allowed.

#### Preamble

The licenses for most software are designed to take away your freedom to share and change it. By contrast, the GNU General Public License is intended to guarantee your freedom to share and change free software--to make sure the software is free for all its users. This General Public License applies to most of the Free Software Foundation's software and to any other program whose authors commit to using it. (Some other Free Software Foundation software is covered by the GNU Library General Public License instead.) You can apply it to your programs, too.

When we speak of free software, we are referring to freedom, not price. Our General Public Licenses are designed to make sure that you have the freedom to distribute copies of free software (and charge for this service if you wish), that you receive source code or can get it if you want it, that you can change the software or use pieces of it in new free programs; and that you know you can do these things.

To protect your rights, we need to make restrictions that forbid anyone to deny you these rights or to ask you to surrender the rights. These restrictions translate to certain responsibilities for you if you distribute copies of the software, or if you modify it. For example, if you distribute copies of such a program, whether gratis or for a fee, you must give the recipients all the rights that you have. You must make sure that they, too, receive or can get the source code. And you must show them these terms so they know their rights.

We protect your rights with two steps: (1) copyright the software, and (2) offer you this license which gives you legal permission to copy, distribute and/or modify the software.

Also, for each author's protection and ours, we want to make certain that everyone understands that there is no warranty for this free software. If the software is modified by someone else and passed on, we want its recipients to know that what they have is not the original, so that any problems introduced by others will not reflect on the original authors' reputations.

Finally, any free program is threatened constantly by software patents. We wish to avoid the danger that redistributors of a free program will individually obtain patent licenses, in effect making the program proprietary. To prevent this, we have made it clear that any patent must be licensed for everyone's free use or not licensed at all.

The precise terms and conditions for copying, distribution and modification follow.

#### GNU GENERAL PUBLIC LICENSE

##### TERMS AND CONDITIONS FOR COPYING, DISTRIBUTION AND MODIFICATION

0. This License applies to any program or other work which contains a notice placed by the copyright holder saying it may be distributed under the terms of this General Public License. The "Program", below, refers to any such program or work, and a "work based on the Program" means either the Program or any derivative work under copyright law: that is to say, a work containing the Program or a portion of it, either verbatim or with modifications and/or translated into another language. (Hereinafter, translation is included without limitation in the term "modification".) Each licensee is addressed as "you".

Activities other than copying, distribution and modification are not covered by this License; they are outside its scope. The act of running the Program is not restricted, and the output from the Program is covered only if its contents constitute a work based on the Program (independent of having been made by running the Program). Whether that is true depends on what the Program does.

1. You may copy and distribute verbatim copies of the Program's source code as you receive it, in any medium, provided that you conspicuously and appropriately publish on each copy an appropriate copyright notice and disclaimer of warranty; keep intact all the notices that refer to this License and to the absence of any warranty; and give any other recipients of the Program a copy of this License along with the Program.

You may charge a fee for the physical act of transferring a copy, and you may at your option offer warranty protection in exchange for a fee.

2. You may modify your copy or copies of the Program or any portion of it, thus forming a work based on the Program, and copy and distribute such modifications or work under the terms of Section 1 above, provided that you also meet all of these conditions:

a) You must cause the modified files to carry prominent notices stating that you changed the files and the date of any change.

b) You must cause any work that you distribute or publish, that in whole or in part contains or is derived from the Program or any part thereof, to be licensed as a whole at no charge to all third parties under the terms of this License.

c) If the modified program normally reads commands interactively when run, you must cause it, when started running for such interactive use in the most ordinary way, to print or display an announcement including an appropriate copyright notice and a notice that there is no warranty (or else, saying that you provide a warranty) and that users may redistribute the program under these conditions, and telling the user how to view a copy of this License. (Exception:

if the Program itself is interactive but does not normally print such an announcement, your work based on the Program is not required to print an announcement.)

These requirements apply to the modified work as a whole. If identifiable sections of that work are not derived from the Program, and can be reasonably considered independent and separate works in themselves, then this License, and its terms, do not apply to those sections when you distribute them as separate works. But when you distribute the same sections as part of a whole which is a work based on the Program, the distribution of the whole must be on the terms of this License, whose permissions for other licensees extend to the entire whole, and thus to each and every part regardless of who wrote it.

Thus, it is not the intent of this section to claim rights or contest your rights to work written entirely by you; rather, the intent is to exercise the right to control the distribution of derivative or collective works based on the Program. In addition, mere aggregation of another work not based on the Program with the Program (or with a work based on the Program) on a volume of a storage or distribution medium does not bring the other work under the scope of this License.

3. You may copy and distribute the Program (or a work based on it, under Section 2) in object code or executable form under the terms of Sections 1 and 2 above provided that you also do one of the following:

- a) Accompany it with the complete corresponding machine-readable source code, which must be distributed under the terms of Sections 1 and 2 above on a medium customarily used for software interchange; or,
- b) Accompany it with a written offer, valid for at least three years, to give any third party, for a charge no more than your cost of physically performing source distribution, a complete machine-readable copy of the corresponding source code, to be distributed under the terms of Sections 1 and 2 above on a medium customarily used for software interchange; or,
- c) Accompany it with the information you received as to the offer to distribute corresponding source code. (This alternative is allowed only for noncommercial distribution and only if you received the program in object code or executable form with such an offer, in accord with Subsection b above.)

The source code for a work means the preferred form of the work for making modifications to it. For an executable work, complete source code means all the source code for all modules it contains, plus any associated interface definition files, plus the scripts used to control compilation and installation of the executable. However, as a special exception, the source code distributed need not include anything that is normally distributed (in either source or binary form) with the major components (compiler, kernel, and so on) of the operating system on which the executable runs, unless that component itself accompanies the executable.

If distribution of executable or object code is made by offering access to copy from a designated place, then offering equivalent access to copy the source code from the same place counts as distribution of the source code, even though third parties are not compelled to copy the source along with the object code.

4. You may not copy, modify, sublicense, or distribute the Program except as expressly provided under this License. Any attempt otherwise to copy, modify, sublicense or distribute the Program is void, and will automatically terminate your rights under this License. However, parties who have received copies, or rights, from you under this License will not have their licenses terminated so long as such parties remain in full compliance.

5. You are not required to accept this License, since you have not signed it. However, nothing else grants you permission to modify or distribute the Program or its derivative works. These actions

are prohibited by law if you do not accept this License. Therefore, by modifying or distributing the Program (or any work based on the Program), you indicate your acceptance of this License to do so, and all its terms and conditions for copying, distributing or modifying the Program or works based on it.

6. Each time you redistribute the Program (or any work based on the Program), the recipient automatically receives a license from the original licensor to copy, distribute or modify the Program subject to these terms and conditions. You may not impose any further restrictions on the recipients' exercise of the rights granted herein. You are not responsible for enforcing compliance by third parties to this License.

7. If, as a consequence of a court judgment or allegation of patent infringement or for any other reason (not limited to patent issues), conditions are imposed on you (whether by court order, agreement or otherwise) that contradict the conditions of this License, they do not excuse you from the conditions of this License. If you cannot distribute so as to satisfy simultaneously your obligations under this License and any other pertinent obligations, then as a consequence you may not distribute the Program at all. For example, if a patent license would not permit royalty-free redistribution of the Program by all those who receive copies directly or indirectly through you, then the only way you could satisfy both it and this License would be to refrain entirely from distribution of the Program.

If any portion of this section is held invalid or unenforceable under any particular circumstance, the balance of the section is intended to apply and the section as a whole is intended to apply in other circumstances.

It is not the purpose of this section to induce you to infringe any patents or other property right claims or to contest validity of any such claims; this section has the sole purpose of protecting the integrity of the free software distribution system, which is implemented by public license practices. Many people have made generous contributions to the wide range of software distributed through that system in reliance on consistent application of that system; it is up to the author/donor to decide if he or she is willing to distribute software through any other system and a licensee cannot impose that choice. This section is intended to make thoroughly clear what is believed to be a consequence of the rest of this License.

8. If the distribution and/or use of the Program is restricted in certain countries either by patents or by copyrighted interfaces, the original copyright holder who places the Program under this License may add an explicit geographical distribution limitation excluding those countries, so that distribution is permitted only in or among countries not thus excluded. In such case, this License incorporates the limitation as if written in the body of this License.

9. The Free Software Foundation may publish revised and/or new versions of the General Public License from time to time. Such new versions will be similar in spirit to the present version, but may differ in detail to address new problems or concerns. Each version is given a distinguishing version number. If the Program specifies a version number of this License which applies to it and "any later version", you have the option of following the terms and conditions either of that version or of any later version published by the Free Software Foundation. If the Program does not specify a version number of this License, you may choose any version ever published by the Free Software Foundation.

10. If you wish to incorporate parts of the Program into other free programs whose distribution conditions are different, write to the author to ask for permission. For software which is copyrighted by the Free Software Foundation, write to the Free Software Foundation; we sometimes make exceptions for this. Our decision will be guided by the two goals of preserving the free status of all derivatives of our free software and of promoting the sharing and reuse of software generally.

## NO WARRANTY

11. BECAUSE THE PROGRAM IS LICENSED FREE OF CHARGE, THERE IS NO WARRANTY FOR THE PROGRAM, TO THE EXTENT

PERMITTED BY APPLICABLE LAW. EXCEPT WHEN OTHERWISE STATED IN WRITING THE COPYRIGHT HOLDERS AND/OR OTHER PARTIES PROVIDE THE PROGRAM „AS IS“ WITHOUT WARRANTY OF ANY KIND, EITHER EXPRESSED OR IMPLIED, INCLUDING, BUT NOT LIMITED TO, THE IMPLIED WARRANTIES OF MERCHANTABILITY AND FITNESS FOR A PARTICULAR PURPOSE. THE ENTIRE RISK AS TO THE QUALITY AND PERFORMANCE OF THE PROGRAM IS WITH YOU. SHOULD THE PROGRAM PROVE DEFECTIVE, YOU ASSUME THE COST OF ALL NECESSARY SERVICING, REPAIR OR CORRECTION.

12. IN NO EVENT UNLESS REQUIRED BY APPLICABLE LAW OR AGREED TO IN WRITING WILL ANY COPYRIGHT HOLDER, OR ANY OTHER PARTY WHO MAY MODIFY AND/OR REDISTRIBUTE THE PROGRAM AS PERMITTED ABOVE, BE LIABLE TO YOU FOR DAMAGES, INCLUDING ANY GENERAL, SPECIAL, INCIDENTAL OR CONSEQUENTIAL DAMAGES ARISING OUT OF THE USE OR INABILITY TO USE THE PROGRAM (INCLUDING BUT NOT LIMITED TO LOSS OF DATA OR DATA BEING RENDERED INACCURATE OR LOSSES SUSTAINED BY YOU OR THIRD PARTIES OR A FAILURE OF THE PROGRAM TO OPERATE WITH ANY OTHER PROGRAMS), EVEN IF SUCH HOLDER OR OTHER PARTY HAS BEEN ADVISED OF THE POSSIBILITY OF SUCH DAMAGES.

END OF TERMS AND CONDITIONS

## How to Apply These Terms to Your New Programs

If you develop a new program, and you want it to be of the greatest possible use to the public, the best way to achieve this is to make it free software which everyone can redistribute and change under these terms.

To do so, attach the following notices to the program. It is safest to attach them to the start of each source file to most effectively convey the exclusion of warranty; and each file should have at least the "copyright" line and a pointer to where the full notice is found.

<one line to give the program's name and a brief idea of what it does>Copyright (C) <year> <name of author>

This program is free software; you can redistribute it and/or modify it under the terms of the GNU General Public License as published by the Free Software Foundation; either version 2 of the License, or (at your option) any later version.

This program is distributed in the hope that it will be useful, but WITHOUT ANY WARRANTY; without even the implied warranty of MERCHANTABILITY or FITNESS FOR A PARTICULAR PURPOSE. See the GNU General Public License for more details.

You should have received a copy of the GNU General Public License along with this program; if not, write to the Free Software Foundation, Inc., 59 Temple Place, Suite 330, Boston, MA 02111-1307 USA

IV.

Den vollständigen korrespondierenden Sourcecode der Software schickt Ihnen die snom technology AG auf Nachfrage gerne auf einem üblichen Datenträger gegen Erstattung der Herstellungskosten in Höhe von EUR 5,- zu.

Der vollständige korrespondierende Sourcecode kann auch über unsere Website unter [http://www.snom.com/gpl\\_.html?&L=0](http://www.snom.com/gpl_.html?&L=0) heruntergeladen werden.

If requested by you, the complete corresponding source code of the Software can be sent by snom technology AG on a standard data storage medium against the reimbursement of the manufacturing costs of EUR 5.- per unit.

The complete corresponding source code of the Software can also be downloaded from our web site [http://www.snom.com/gpl\\_.html?&L=0](http://www.snom.com/gpl_.html?&L=0).

V..

Weitere Informationen finden Sie auch unter <http://www.snom.com>.

For further information see <http://www.snom.com>.

snom technology AG  
Charlottenstr. 68-71  
10117 Berlin, Deutschland  
Tel. +49 30 39 83 3-0  
Fax +49 30 39 83 31 11  
info@snom.com, sales@snom.com

snom technology, Inc.  
18 Commerce Way, Suite 6000  
Woburn, MA 01801, USA  
Tel. 781-569-2044  
Fax 978-998-7883  
infoUSA@snom.com

snom UK Ltd  
Aspect Court  
47 Park Square East  
Leeds, LS12NL, UK  
Tel. +44 1133 503 111  
Fax +44 1133 503 110  
uksales@snom.com, info@snom.com

snom France SARL  
6 Parc des fontenelles  
78870 Bailly, France  
Tel. +33 1 80 87 62 87  
Fax +33 1 80 87 62 88  
info@snom.com, sales@snom.com

snom technology SRL  
Via A. Lusardi 10  
20122 Milano, Italia  
Tel +39 02 00611212  
Fax +39 02 93661864  
info@snom.com, sales@snom.com

snom technology Ltd.  
Rm. A2, 3F, No. 37, Ln. 258  
Ruiguang Rd., Neihu Dist.  
Taipei City 114, Taiwan  
Tel +886-2-8751-1120  
Fax +886-2-8751-1130  
infoASIA@snom.com

**Your specialist retailer - Ihr Fachhändler -  
Votre distributeur - Su distribuidor - Il tuo rivenditore:**

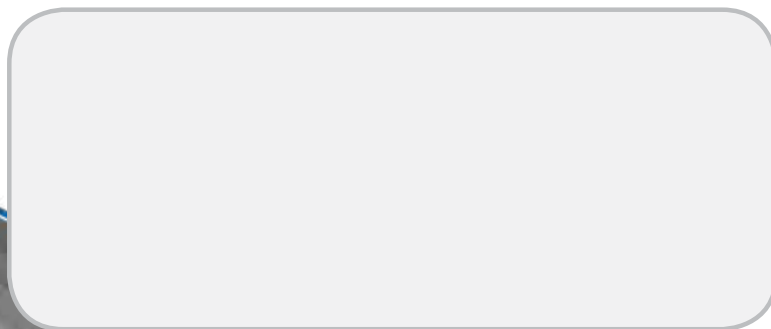

snom technology AG  
Charlottenstr. 68-71  
10117 Berlin, Deutschland  
Tel. +49 30 39 83 3-0  
Fax +49 30 39 83 31 11  
info@snom.com, sales@snom.com

snom technology, Inc.  
18 Commerce Way, Suite 6000  
Woburn, MA 01801, USA  
Tel. 781-569-2044  
Fax 978-998-7883  
infoUSA@snom.com

snom UK Ltd  
Aspect Court  
47 Park Square East  
Leeds, LS12NL, UK  
Tel. +44 1133 503 111  
Fax +44 1133 503 110  
uksales@snom.com, info@snom.com

snom France SARL  
6 Parc des fontenelles  
78870 Bailly, France  
Tel. +33 1 80 87 62 87  
Fax +33 1 80 87 62 88  
info@snom.com, sales@snom.com

snom technology SRL  
Via A. Lusardi 10  
20122 Milano, Italia  
Tel +39 02 00611212  
Fax +39 02 93661864  
info@snom.com, sales@snom.com

snom technology Ltd.  
Rm. A2, 3F, No. 37, Ln. 258  
Ruiguang Rd., Neihu Dist.  
Taipei City 114, Taiwan  
Tel +886-2-8751-1120  
Fax +886-2-8751-1130  
infoASIA@snom.com

**Your specialist retailer - Ihr Fachhändler -  
Votre distributeur - Su distribuidor - Il tuo rivenditore:**

